UDC2500
Universal Digital Controller
Limit Control Model
Product Manual

51-52-25-136

March 2007







About This Document

Abstract

This document provides descriptions and procedures for the Installation, Configuration, Operation, and Troubleshooting of your UDC2500 Controller.

Symbol Definitions

The following table lists those symbols used in this document to denote certain conditions.

Symbol	Definition
	This CAUTION symbol on the equipment refers the user to the Product Manual for additional information. This symbol appears next to required information in the manual.
	WARNING PERSONAL INJURY: Risk of electrical shock. This symbol warns the user of a potential shock hazard where HAZARDOUS LIVE voltages greater than 30 Vrms, 42.4 Vpeak, or 60 VDC may be accessible. Failure to comply with these instructions could result in death or serious injury.
	ATTENTION, Electrostatic Discharge (ESD) hazards. Observe precautions for handling electrostatic sensitive devices
	Protective Earth (PE) terminal. Provided for connection of the protective earth (green or green/yellow) supply system conductor.
	Functional earth terminal. Used for non-safety purposes such as noise immunity improvement. NOTE: This connection shall be bonded to protective earth at the source of supply in accordance with national local electrical code requirements.
	Earth Ground. Functional earth connection. NOTE: This connection shall be bonded to Protective earth at the source of supply in accordance with national and local electrical code requirements.
	Chassis Ground. Identifies a connection to the chassis or frame of the equipment shall be bonded to Protective Earth at the source of supply in accordance with national and local electrical code requirements.

Contents

1	INTRODUCTION	1
1.1	Overview.....	1
1.1.1	Function of keys.....	3
1.2	Process Instrument Explorer Software.....	4
1.3	CE Conformity (Europe).....	6
2	INSTALLATION.....	7
2.1	Overview.....	7
2.2	Condensed Specifications	8
2.3	Model Number Interpretation	11
2.4	Limit and Alarm Relay Contact Information	13
2.5	Mounting.....	14
2.6	Wiring	16
2.6.1	Electrical Considerations	16
2.7	Wiring Diagrams.....	18
2.8	Limit Control Application Diagram.....	25
3	CONFIGURATION.....	26
3.1	Overview.....	26
3.2	Configuration Prompt Hierarchy	27
3.3	Configuration Procedure.....	28
3.4	Lock Set Up Group	29
3.5	Limit Set Up Group	30
3.6	Input 1 Set Up Group.....	31
3.7	Options Set Up Group.....	35
3.8	Communications Set Up Group.....	37
3.9	Alarms Set Up Group.....	39
3.10	Display Set Up Group	43
3.11	P.I.E. Tool Ethernet and Email Configuration Screens.....	45
3.12	Configuration Record Sheet.....	48
4	OPERATING THE LIMIT CONTROLLER	49
4.1	Overview.....	49
4.2	Operator Interface	50
4.3	Entering a Security Code	50
4.4	Lockout Feature	51
4.5	Monitoring Your Limit Controller.....	52

4.6	Operating Your Limit Controller	54
4.7	Alarm Setpoints	57
4.8	P.I.E. Tool Maintenance Screens	58
4.9	Configuring your Ethernet Connection.....	64
5	INPUT CALIBRATION.....	69
5.1	Overview.....	69
5.2	Minimum and Maximum Range Values.....	70
5.3	Preliminary Information.....	72
5.4	Input 1 Set Up Wiring.....	73
5.5	Input 1 Calibration Procedure.....	78
5.6	Restore Input Factory Calibration.....	79
6	OUTPUT CALIBRATION.....	83
6.1	Overview.....	83
6.2	Auxiliary Output Calibration	83
6.3	Restore Output Factory Calibration	85
7	TROUBLESHOOTING/SERVICE	87
7.1	Overview.....	87
7.2	Troubleshooting Aids.....	88
7.3	Power-up Tests.....	90
7.4	Status Tests	90
7.5	Background Tests.....	91
7.6	Controller Failure Symptoms.....	93
7.7	Troubleshooting Procedures	94
7.8	Restoring Factory Configuration	100
8	PARTS LIST	101
8.1	Exploded View.....	101
8.2	Removing the chassis.....	103
9	MODBUS RTU FUNCTION CODES.....	104
9.1	Overview.....	104
9.2	General Information.....	104
9.3	Function Code 20 (14h) - Read Configuration Reference Data.....	106
9.3.1	Read Configuration Examples	108
9.4	Function Code 21 (15h) - Write Configuration Reference Data.....	110
9.4.1	Write Configuration Examples	112

10	MODBUS READ, WRITE AND OVERRIDE PARAMETERS PLUS EXCEPTION CODES.....	113
10.1	Overview	113
10.2	Reading Control Data.....	115
10.3	Miscellaneous Read Onlys	115
10.3.1	Register Addresses for Read Onlys	115
10.4	Configuration Parameters	116
10.4.1	Lock.....	116
10.4.2	Limit	117
10.4.3	Input 1.....	118
10.4.4	Options	120
10.4.5	Communications.....	121
10.4.6	Alarms	122
10.4.7	Display.....	124
10.5	Modbus RTU Exception Codes.....	125
11	ETHERNET TCP/IP	127
11.1	Overview	127
12	FURTHER INFORMATION.....	128
12.1	Modbus RTU Serial Communications	128
12.2	Modbus Messaging on TCP/IP.....	128
12.3	How to Apply Digital Instrumentation in Severe Electrical Noise Environments	128
13	INDEX.....	129

Tables

Table 2-1 Condensed Specifications	8
Table 2-2 Limit Relay Contact Information	13
Table 2-3 Alarm Relay Contact Information	13
Table 2-4 Mounting Procedure	15
Table 2-5 Permissible Wiring Bundling	17
Table 2-6 Terminals for connecting a UDC to a MDI Compliant Hub or Switch	23
Table 2-7 Terminals for connecting a UDC directly to a PC utilizing a straight-through cable	23
Table 3-1 Configuration Topics	26
Table 3-2 Configuration Prompt Hierarchy	27
Table 3-3 Configuration Procedure	28
Table 3-4 LOCK Group Function Prompts	29
Table 3-5 LIMIT Group Function Prompts	30
Table 3-6 INPUT 1 Group Function Prompts	31
Table 3-7 OPTION Group Function Prompts	35
Table 3-8 Communications Group Function Prompts	37
Table 3-9 ALARMS Group Function Prompts	39
Table 3-10 DISPLY Group Function Prompts	43
Table 4-1 Procedure to Enter a Security Code	51
Table 4-2 Annunciators	52
Table 4-3 Error Messages	53
Table 4-4 Using Contact Input Option	56
Table 4-5 Procedure for Displaying Alarm Setpoints	57
Table 5-1 Voltage, Milliamp and Resistance Equivalents for Input 1 Range Values	70
Table 5-2 Equipment Needed	72
Table 5-3 Set Up Wiring Procedure for Thermocouple Inputs Using an Ice Bath	73
Table 5-4 Set Up Wiring Procedure for Thermocouple Inputs using Thermocouple Source	74
Table 5-5 Set Up Wiring Procedure for RTD Inputs	74
Table 5-6 Wiring Connections for Radamatic, Thermocouple Differential, Millivolts or Volts (Except 0 to 10 Volts)	75
Table 5-7 Procedure to determine calibration voltages for Thermocouple Differential input types other than the Factory Setting	75
Table 5-8 Set Up Wiring Procedure for 0 to 10 Volts	76
Table 5-9 Set Up Wiring Procedure for Milliampere Inputs	77
Table 5-10 Input 1 Calibration Procedure	78
Table 5-11 Restore Input Factory Calibration	80
Table 6-1 Set Up Wiring Procedure for Auxiliary Output	84
Table 6-2 Auxiliary Output Calibration Procedure	85
Table 6-3 Restore Factory Calibration	86
Table 7-1 Procedure for Identifying the Software Version	89
Table 7-2 Procedure for Displaying the Status Test Results	90
Table 7-3 Background Tests	91
Table 7-4 Controller Failure Symptoms	93
Table 7-5 Troubleshooting Power Failure Symptoms	95
Table 7-6 Troubleshooting Latching Output Relay Failure	96
Table 7-7 Troubleshooting Alarm Relay Output Failure	96
Table 7-8 Troubleshooting a Keyboard Failure	97
Table 7-9 Troubleshooting a RS-485 Communications Failure	98
Table 7-10 Troubleshooting Auxiliary Output Failure	99

Table 7-11 Restoring Factory Configuration _____	100
Table 8-1 Parts Identification _____	102
Table 8-2 Parts Not Shown _____	102
Table 9-1 Integer Parameter Type _____	105
Table 9-2 Floating Point Parameter Type _____	105
Table 9-3 Register Address Format for Function Code 20 _____	107
Table 9-4 Register Address Format for Function Code 21 _____	111
Table 10-1 Control Data Parameters _____	115
Table 10-2 Miscellaneous Read Onlys _____	115
Table 10-3 Set-up Group Lock _____	116
Table 10-4 Set-up Group Limit _____	117
Table 10-5 Set-up Group – Input 1 _____	118
Table 10-6 Set-up Group – Options _____	120
Table 10-7 Set-up Group – Communications _____	121
Table 10-8 Set-up Group – Alarms _____	122
Table 10-9 Set-up Group – Display _____	124
Table 10-10 Modbus RTU Data Layer Status Exception Codes _____	126

Figures

Figure 1-1 UDC2500 Operator Interface _____	2
Figure 1-2 Screen capture of Process Instrument Explorer running on a Pocket PC _____	4
Figure 1-3 Depiction of infrared communications _____	5
Figure 2-1 Model Number Interpretation _____	12
Figure 2-2 Mounting Dimensions (not to scale) _____	14
Figure 2-3 Mounting Method _____	15
Figure 2-4 Composite Wiring Diagram _____	18
Figure 2-5 Mains Power Supply _____	19
Figure 2-6 Input 1 Connections _____	20
Figure 2-7 Electromechanical Relay Output _____	21
Figure 2-8 Solid State Relay Output _____	21
Figure 2-9 Open Collector Output _____	22
Figure 2-10 RS-422/485 Communications Option Connections _____	22
Figure 2-11 Ethernet Communications Option Connections _____	23
Figure 2-12 Auxiliary Output and Digital Inputs Option Connections _____	24
Figure 2-13 Transmitter Power for 4-20 mA — 2 wire Transmitter Using Open Collector Alarm 2 Output _____	24
Figure 2-14 Transmitter Power for 4-20 mA — 2 Wire Transmitter Using Auxiliary Output _____	25
Figure 2-15 Limit Controller Application Diagram _____	25
Figure 3-1 Ethernet Configuration Screen _____	45
Figure 3-2 Email Configuration Screen _____	46
Figure 4-1 Operator Interface _____	50
Figure 4-2 Maintenance Data Menu _____	58
Figure 4-3 Loop Data Maintenance Screen _____	59
Figure 4-4 Alarm Details Maintenance Screen _____	60
Figure 4-5 Digital Input Details Screen _____	61
Figure 4-6 Status Data Maintenance Screen _____	62
Figure 4-7 Ethernet Status Maintenance Screen _____	63
Figure 4-8 IR Communications Address _____	64
Figure 4-9 Configuration Upload in Progress _____	65
Figure 4-10 Ethernet Communications Type Selection _____	66
Figure 4-11 Ethernet Communications Address _____	67
Figure 4-12 Configuration Upload in Progress _____	68
Figure 5-1 Input 1 Wiring Terminals _____	72
Figure 5-2 Wiring Connections for Thermocouple Inputs Using an Ice Bath _____	73
Figure 5-3 Wiring Connections for Thermocouple Inputs Using Thermocouple Source _____	74
Figure 5-4 Wiring Connections for RTD (Resistance Thermometer Device) _____	74
Figure 5-5 Wiring Connections for Radiamatic, Millivolts, Volts or Thermocouple Differential (Except 0 to 10 Volts) _____	75
Figure 5-6 Wiring Connections for 0 to 10 Volts _____	76
Figure 5-7 Wiring Connections for 0 to 20 mA or 4 to 20 mA Inputs _____	77
Figure 6-1 Wiring Connections for Calibrating Auxiliary Output _____	84
Figure 8-1 UDC2500 Exploded View _____	101

1 Introduction

1.1 Overview

Function

UDC2500 Limit Controllers accept input signals from any of several types of external sensors such as Thermocouples (T/Cs) and Resistance Temperature Detectors (RTDs). It conditions these signals, as necessary, to derive the equivalent Process Variable (PV) value that drives various circuits in the controller.

The equivalent PV signal is compared with the Limit control set point and any error signal from the differential amplifier de-energizes the coil of an electromechanical, single-pole, dual-throw (SPDT) limit output relay.

When de-energized, the output relay “Locks Out” and remains that way until the PV input signal drops below the High Limit Set Point or goes above the Low Limit Set Point and the controller is reset manually via the keyboard or from a remote location (Contact Input Option).

The contact of the output relay terminates at the rear terminal of the controller to which you make the appropriate field wiring connections.

A flashing “LIMIT” in the lower display indicates that the output relay is de-energized.

Features

- 90 – 264 Vac or 24 Vac/dc Power Supply
- Input/Output Isolation
- Isolated Auxiliary Current Output / Digital Inputs
- Modbus® RS-485 or Ethernet TCP/IP Communications

High Limit Controller

When the PV input signal is below the limit set point, the output relay energizes. If the PV signal exceeds the limit set point, the output relay de-energizes and the flashing “LIMIT” display is turned on.

When the PV signal returns to a value below the limit set point, the controller can be reset manually using the RESET key or Contact Input Option.

Low Limit Controller

When the PV input signal is above the limit set point, the output relay energizes. If the PV signal falls below the limit set point, the output relay de-energizes and the flashing “LIMIT” display is turned on.

When the PV signal returns to a value above the limit set point, the controller can be reset manually using the RESET key or Contact Input Option.

Easy to read displays

The dedicated vacuum fluorescent displays with multi-language prompts make the operator interface easy to read, understand and operate. Programmed sequences of displays assure quick and accurate entry of all configurable parameters.

Easy to operate

Simple keystrokes let you select input and range configuration, set the operating parameters that meet you process control needs now, and change them later to meet new ones.

Mount anywhere

This instrument is intended for industrial control applications. It must be panel mounted with the wiring terminals enclosed within the panel. The instrument is environmentally hardened and, when suitably enclosed, can be mounted anywhere in plant or factory, on the wall, or even on the process machine itself. The front face is NEMA3 and IP55 rated and can be easily upgraded to NEMA4X and IP66 for the most severe hose-down applications. It withstands ambient temperatures up to 55°C (133°F) and resists the effects of vibration and shock.





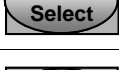





Figure 1-1 UDC2500 Operator Interface

1.1.1 Function of keys

Table 1-1 shows each key on the operator interface and defines its function.

Table 1-1 Function of Keys

Key	Function
	<ul style="list-style-type: none"> Places the controller in the Configuration Set Up group select mode. Sequentially displays Set Up groups and allows the FUNCTION key to display individual functions in each Set Up group.
	<ul style="list-style-type: none"> Used in conjunction with the SET UP key to select the individual functions of a selected Configuration Set Up group. Used during field calibration procedure.
	<ul style="list-style-type: none"> Selects an operating parameter to be shown in the lower display.
	<p>MAN-AUTO This function is not available on the Limit Controller.</p> <p>RESET Reset the Limit Relay.</p>
	This key does not function on the Limit Controller
	<ul style="list-style-type: none"> Acknowledges a latched alarm 1. Acknowledges Diagnostic Messages.
	<ul style="list-style-type: none"> Increases the selected parameter value.
	<ul style="list-style-type: none"> Decreases the selected parameter value.

1.2 Process Instrument Explorer Software

Overview

Process Instrument Explorer lets you configure your instrument on a desktop/laptop or Pocket PC. For details see Process Instrument Explorer manual #51-52-25-131.

Features

- Create configurations with intuitive software program running on either a Pocket PC, a Desktop or a laptop computer. ·
- Create/edit configurations live, just connect software to controller via comm port.·
- Create/edit configurations offline and download to controller later via comm. port.·
- Port types available on every UDC2500:·
 - infrared,·
 - RS 485,
 - Ethernet.·
- Same port types on UDC3200 and UDC3500 allow interconnectivity.
- This software is available in English, Spanish, Italian, German and French.

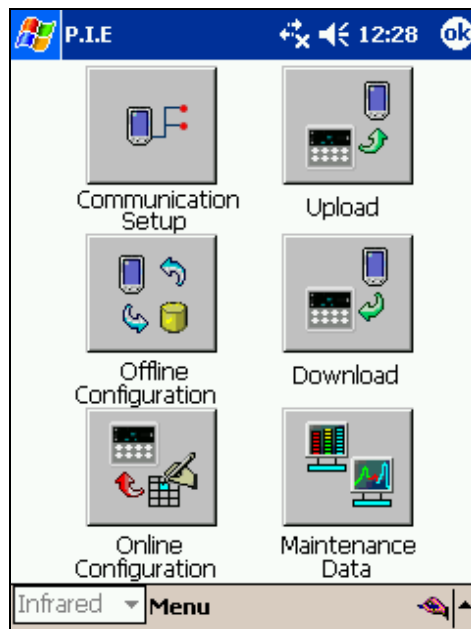

Figure 1-2 Screen capture of Process Instrument Explorer running on a Pocket PC

Infrared communications

The infrared connection provides a non-intrusive wireless connection with the instrument and maintains NEMA4X AND IP66 integrity.

No need to get access to the back of the controller to communicate with the instrument, no need to take your screw driver to wire the communication cable, no wiring mistake possible. You can now duplicate an instrument's configuration, upload or download a new configuration in a matter of seconds, just by pointing your Pocket PC in the direction of the instrument.

It takes just a few seconds to upload a configuration from an instrument. You can then save the configuration file onto your PC or pocket PC for review, modification or archiving. Furthermore, this software also gives you important maintenance information on the controller: instantly, get information on the current operating parameters, digital inputs and alarm status, identify internal or analog input problems.

Question: What if I have several controllers on the same panel? How can I be sure I am communicating with the correct one?

Answer: The infrared port of the controller is normally "off". You activate the infrared port by pressing any controller's key. You can now communicate. After 4 minutes, the port will be shut down again. Also, in the Communications Group "IR ENABLE" may be disabled to prohibit IR communications.



Figure 1-3 Depiction of infrared communications

1.3 CE Conformity (Europe)

This product is in conformity with the protection requirements of the following European Council Directives: **73/23/EEC**, the Low Voltage Directive, and **89/336/EEC**, the EMC Directive. Conformity of this product with any other “CE Mark” Directive(s) shall not be assumed.

Product Classification: Class I: Permanently connected, panel-mounted Industrial Control Equipment with protective earthing (grounding) (EN61010-1).

Enclosure Rating: This controller must be panel-mounted with the rear terminals enclosed within the panel. The front panel of the controller is rated at NEMA4X and IP66 when properly installed.

Installation Category (Overvoltage Category): Category II (EN61010-1)

Pollution Degree: Pollution Degree 2: Normally non-conductive pollution with occasional conductivity caused by condensation. (Ref. IEC 664-1)

EMC Classification: Group 1, Class A, ISM Equipment (EN61326, emissions), Industrial Equipment (EN61326, immunity)

Method of EMC Assessment: Technical File (TF)

Declaration of Conformity: 51453655

Deviation from the installation conditions specified in this manual, and the special conditions for CE conformity in Subsection 2.1, may invalidate this product’s conformity with the Low Voltage and **EMC** Directives.

ATTENTION

The emission limits of EN61326 are designed to provide reasonable protection against harmful interference when this equipment is operated in an industrial environment. Operation of this equipment in a residential area may cause harmful interference. This equipment generates, uses, and can radiate radio frequency energy and may cause interference to radio and television reception when the equipment is used closer than 30 meters (98 feet) to the antenna(e). In special cases, when highly susceptible apparatus is used in close proximity, the user may have to employ additional mitigating measures to further reduce the electromagnetic emissions of this equipment.

WARNING

If this equipment is used in a manner not specified by the manufacturer, the protection provided by the equipment may be impaired.

2 Installation

2.1 Overview

Introduction

Installation of the UDC2500 consists of mounting and wiring the controller according to the instructions given in this section. Read the pre-installation information, check the model number interpretation (Subsection 2.3), and become familiar with your model selections, then proceed with installation.

What's in this section?

The following topics are covered in this section.

TOPIC	See Page
2.1 Overview	7
2.2 Condensed Specifications	8
2.3 Model Number Interpretation	11
2.4 Control and Alarm Relay Contact Information	13
2.5 Mounting	14
2.6 Wiring	16
2.7 Wiring Diagrams	18
Composite Wiring Diagram	18
AC Line Voltage	19
Input 1 Connections	20
Relay Output	
Electromechanical	21
Solid State	21
Open Collector	22
RS-422/485 Communications Option	22
Ethernet Communications Option	23
Auxiliary Output and Digital Inputs Option	24
Transmitter Power using Open Collector Output	24
Transmitter Power using Auxiliary Output	25
2.8 Limit Control Application Diagram	25

Pre-installation Information

If the controller has not been removed from its shipping carton, inspect the carton for damage then remove the controller.

- Inspect the unit for any obvious shipping damage and report any damage due to transit to the carrier.
- Make sure a bag containing mounting hardware is included in the carton with the controller.
- Check that the model number shown on the inside of the case agrees with what you have ordered.

2.2 Condensed Specifications

We recommend that you review and adhere to the operating limits listed in Table 2-1 when you install your controller.

Table 2-1 Condensed Specifications

Analog Inputs	<p><i>Accuracy:</i> $\pm 0.25\%$ of full scale typical (± 1 digit for display) Can be field calibrated to $\pm 0.05\%$ of full scale typical 16-bit resolution typical</p> <p><i>Sampling Rate:</i> Both inputs are sampled six times per second</p> <p><i>Temperature Stability:</i> $\pm 0.01\%$ of Full Scale span / °C change—typical</p> <p><i>Input Impedance:</i> 4-20 Milliampere Input: 250 ohms 0-10 Volt Input: 200K ohms All Others: 10 megohms</p> <p><i>Maximum Lead Wire Resistance:</i> Thermocouples: 50 ohms/leg 100 ohm, 200 ohm and 500 ohm RTD: 100 ohms/leg 100 ohm Low RTD: 10 ohms/leg</p>
Analog Input Signal Failure Operation	<p><i>Burnout Selections:</i> Upscale, Downscale <i>Thermocouple Health:</i> Good, Failing, Failure Imminent or Failed</p>
Stray Rejection	<p>Common Mode <i>AC (50 or 60 Hz):</i> 120 dB (with maximum source impedance of 100 ohms) or ± 1 LSB (least significant bit) whichever is greater with line voltage applied. <i>DC:</i> 120 dB (with maximum source impedance of 100 ohms) or a ± 1 LSB whichever is greater with 120 Vdc applied. <i>DC (to 1 KHz):</i> 80 dB (with maximum source of impedance of 100 ohms) or ± 1 LSB whichever is greater with 50 Vac applied.</p> <p>Normal Mode <i>AC (50 or 60 Hz):</i> 60 dB (with 100 % span peak-to-peak maximum)</p>
Digital Inputs (One) (Optional)	<p>+30 Vdc source for external dry contacts or isolated solid state contacts. Digital Inputs are isolated from line power, earth ground, analog inputs and all outputs except for the Second Current Output.</p>

Controller Output Types	<p>Electromechanical Relay</p> <p>SPDT contacts. Both Normally Open and Normally Closed contacts are brought out to the rear terminals. Internally socketed.</p> <p><i>Resistive Load:</i> 5 amps @ 120 Vac or 240 Vac or 30 Vdc <i>Inductive Load (cosφ = 0.4):</i> 3 amps @ 130 Vac or 250 Vac <i>Inductive Load (L/R = 7 msec):</i> 3.5 amps @ 30 Vdc <i>Motor:</i> 1/6 H.P.</p> <p>Solid State Relay</p> <p>Zero-crossing type SPST solid state contacts consisting of a triac N.O. output. Internally socketed.</p> <p><i>Resistive Load:</i> 1.0 amp @ 25°C and 120 or 240 Vac, 0.5 amp @ 55°C and 120 or 240 Vac <i>Inductive Load:</i> 50 VA @ 120 Vac or 240 Vac <i>Minimum Load:</i> 20 milliamps</p> <p>Open Collector Outputs (One or Two)</p> <p>Socketed assembly replacing a relay. Opto-isolated from all other circuits except current output and not from each other. Internally powered @ 30 Vdc. Note: Applying an external power supply to this output will damage the instrument.</p> <p><i>Maximum Sink Current:</i> 20 mA <i>Short-circuit current limit:</i> 100 mA</p>
Alarm Outputs (Optional)	<p>One or two SPDT Electromechanical relays.</p> <p>Up to four setpoints are independently set as high or low alarm, two for each relay. Setpoint can be on Process Variable, Deviation, PV Rate, Communication Shed or Thermocouple Health. A single adjustable hysteresis of 0.0 to 100.0% is provided.</p> <p><i>Alarm Relay Contacts Rating:</i> Resistive Load: 5 amps at 120 Vac or 240 Vac or 30 Vdc</p>
Isolation (Functional)	<p><i>Analog Inputs:</i> are isolated from all other circuits at 850Vdc for 2 seconds, but not from each other.</p> <p><i>Analog Outputs:</i> are isolated from all other circuits at 850Vdc for 2 seconds.</p> <p><i>AC Power:</i> is electrically isolated from all other inputs and outputs to withstand a HIPOT potential of 1900Vdc for 2 seconds per Annex K of EN61010-1.</p> <p><i>Relay Contacts:</i> with a working voltage of 115/230 Vac, are isolated from each other and all other circuits at 345Vdc for 2 seconds.</p>
RS422/485 Modbus RTU Communications Interface (Optional)	<p><i>Baud Rate:</i> 4800, 9600, 19,200 or 38,400 baud selectable <i>Data Format:</i> Floating point or integer <i>Length of Link:</i> 2000 ft (600 m) max. with Belden 9271 Twinax Cable and 120 ohm termination resistors 4000 ft. (1200 m) max. with Belden 8227 Twinax Cable and 100 ohm termination resistors <i>Link Characteristics:</i> Two-wire, multi-drop Modbus RTU protocol, 15 drops maximum or up to 31 drops for shorter link length.</p>
Ethernet TCP/IP Communications Interface (Optional)	<p><i>Type:</i> 10Base-T <i>Length of Link:</i> 330 ft. (100 m) maximum <i>Link Characteristics:</i> Four-wire, single drop, five hops maximum <i>IP Address:</i> IP Address is 10.0.0.2 as shipped from the Factory <i>Recommended network configuration:</i> Use Switch rather than Hub in order to maximize UDC Ethernet performance</p>
Infrared Communications (Optional)	<p><i>Type:</i> Serial Infrared (SIR) <i>Length of Link:</i> 3 ft. (1 m) maximum for IrDA 1.0 compliant devices <i>Baud Rate:</i> 19,200 or 38,400 baud selectable</p>
Power Consumption	<p>20 VA maximum (90 to 264 Vac) 15 VA maximum (24 Vac/dc)</p>
Power Inrush Current	<p>10A maximum for 4 ms (under operating conditions), reducing to a maximum of 225 mA (90 to 264 Vac operation) or 750 mA (24 Vac/dc operation) after one second.</p> <p>CAUTION: When applying power to more than one instrument, make sure that sufficient power is supplied. Otherwise, the instruments may not start up normally due to voltage drop from the inrush current.</p>

Installation

Weight	3 lbs. (1.3 kg)
---------------	-----------------

Environmental and Operating Conditions				
Parameter	Reference	Rated	Operative Limits	Transportation and Storage
Ambient Temperature	25 ± 3 °C 77 ± 5 °F	15 to 55 °C 58 to 131 °F	0 to 55 °C 32 to 131 °F	-40 to 66 °C -40 to 151 °F
Relative Humidity	10 to 55*	10 to 90*	5 to 90*	5 to 95*
Vibration				
Frequency (Hz)	0	0 to 70	0 to 200	0 to 200
Acceleration (g)	0	0.4	0.6	0.5
Mechanical Shock				
Acceleration (g)	0	1	5	20
Duration (ms)	0	30	30	30
Line Voltage (Vdc)	+24 ± 1	22 to 27	20 to 27	--
Line Voltage (Vac)				
90 to 240 Vac	120 ± 1 240 ± 2	90 to 240	90 to 264	-- --
24 Vac	24 ± 1	20 to 27	20 to 27	--
Frequency (Hz) (For Vac)	50 ± 0.2 60 ± 0.2	49 to 51 59 to 61	48 to 52 58 to 62	-- --

* The maximum moisture rating only applies up to 40 °C (104 °F). For higher temperatures, the RH specification is derated to maintain constant moisture content.

2.3 Model Number Interpretation

Introduction

Write your controller's model number in the spaces provided below and circle the corresponding items in each table. This information will also be useful when you wire your controller.

KEY NUMBER - UDC2500 Single Loop Controller		Selection	Availability	
Description		DC	2500	2501
Digital Controller for use with 90 to 264Vac Power		DC2500	↓	↓
Digital Controller for use with 24Vac/dc Power		DC2501	↓	↓

TABLE I - Specify Control Output and/or Alarms		Selection	Availability	
		DC	2500	2501
Output #1	Electro Mechanical Relay (5 Amp Form C) Solid State Relay (1 Amp) Open Collector transistor output	E _	•	•
		A _	•	•
		T _	•	•
Output #2 and Alarm #1 or Alarms 1 and 2	No Additional Outputs or Alarms One Alarm Relay Only E-M Relay (5 Amp Form C) Plus Alarm 1 (5 Amp Form C Relay) Solid State Relay (1 Amp) Plus Alarm 1 (5 Amp Form C Relay) Open Collector Plus Alarm 1 (5 Amp Form C Relay)	_ 0	•	•
		_ B	•	•
		_ E	•	•
		_ A	•	•
		_ T	•	•

TABLE II - Communications and Software Selections		Selection	Availability	
		DC	2500	2501
Communications	None Auxiliary Output/Digital Inputs (1 Aux and 1 DI or 2 DI) RS-485 Modbus Plus Auxiliary Output/Digital Inputs 10 Base-T Ethernet (Modbus RTU) Plus Auxiliary Output/Digital Inputs	0 _ _ _	•	•
		1 _ _ _	•	•
		2 _ _ _	•	•
		3 _ _ _	•	•
Software Selections	Limit Controller	_ L _ _	•	•
Reserved	No Selection	_ _ 0 _	•	•
Infrared interface	None Infrared Interface Included (Can be used with a Pocket PC)	_ _ _ 0	•	•
		_ _ _ R	•	•

TABLE III - Input 1 can be changed in the field using external resistors		Selection	Availability	
		DC	2500	2501
Input 1	TC, RTD, mV, 0-5V, 1-5V TC, RTD, mV, 0-5V, 1-5V, 0-20mA, 4-20mA TC, RTD, mV, 0-5V, 1-5V, 0-20mA, 4-20mA, 0-10V	1 _ _	•	•
		2 _ _	•	•
		3 _ _	•	•
Input 2	None	_ 00	•	•

TABLE IV - Options		Selection	Availability	
		DC	2500	2501
Approvals	CE, UL and CSA (Standard) CE, UL, CSA and FM	0 _ _ _	•	•
		1 _ _ _	b	b
Tags	None Stainless Steel Customer ID Tag - 3 lines w/22 characters/line	_ 0 _ _	•	•
		_ T _ _	•	•
Future Options	None	_ _ 0 _	•	•
	None	_ _ _ 0	•	•

TABLE V - Product Manuals		Selection	Availability	
		DC	2500	2501
Manuals	Product Information on CD - All Languages English Manual (51-52-25-127) French Manual (51-52-25-127-FR) German Manual (51-52-25-127-DE) Italian Manual (51-52-25-127-IT) Spanish Manual (51-52-25-127-SP)	0 _	•	•
		E _	•	•
		F _	•	•
		G _	•	•
		I _	•	•
		S _	•	•
Certificate	None Certificate of Conformance (F3391)	_ 0	•	•
		_ C	•	•

continued

Limit Controller Restrictions/Comments:			
1. FM approved units with communications are limited to read only.			
2. FM approved units are restricted to TC and RTD type inputs.			
3. UL listed for regulatory use only.			
b	II	_L_	
c	Input 2 Not Available with Limit Model		

Figure 2-1 Model Number Interpretation

2.4 Limit and Alarm Relay Contact Information

Limit Relay

ATTENTION

The Limit relay is designed to operate in a Failsafe mode. This results in momentary (5 seconds maximum) limit action when power is initially applied, until the unit completes self-diagnostics. If power is lost to the unit, the Limit Control Relay will still function.

Table 2-2 Limit Relay Contact Information

Unit Power	Limit Control Relay Wiring	Variable NOT in Limit State		Variable in Limit State	
		Relay Contact	Indicators	Relay Contact	Indicators
Off	N.O.	Open	Off	Open	Off
	N.C.	Closed		Closed	
On	N.O.	Closed	Off	Open	On
	N.C.	Open		Closed	

Alarm Relays

ATTENTION

Alarm relays are designed to operate in a failsafe mode (that is, de-energized during alarm state). This results in alarm actuation when power is OFF or when initially applied, until the unit completes self diagnostics. If power is lost to the unit, the alarms will de-energize and thus the alarm contacts will close.

Table 2-3 Alarm Relay Contact Information

Unit Power	Alarm Relay Wiring	Variable NOT in Alarm State		Variable in Alarm State	
		Relay Contact	Indicators	Relay Contact	Indicators
Off	N.O.	Open	Off	Open	Off
	N.C.	Closed		Closed	
On	N.O.	Closed	Off	Open	On
	N.C.	Open		Closed	

2.5 Mounting

Physical Considerations

The controller can be mounted on either a vertical or tilted panel using the mounting kit supplied. Adequate access space must be available at the back of the panel for installation and servicing activities.

- Overall dimensions and panel cutout requirements for mounting the controller are shown in Figure 2-2.
- The controller's mounting enclosure must be grounded according to CSA standard C22.2 No. 0.4 or Factory Mutual Class No. 3820 paragraph 6.1.5.
- The front panel is moisture rated NEMA3 and IP55 rated and can be easily upgraded to NEMA4X and IP66.

Overall Dimensions

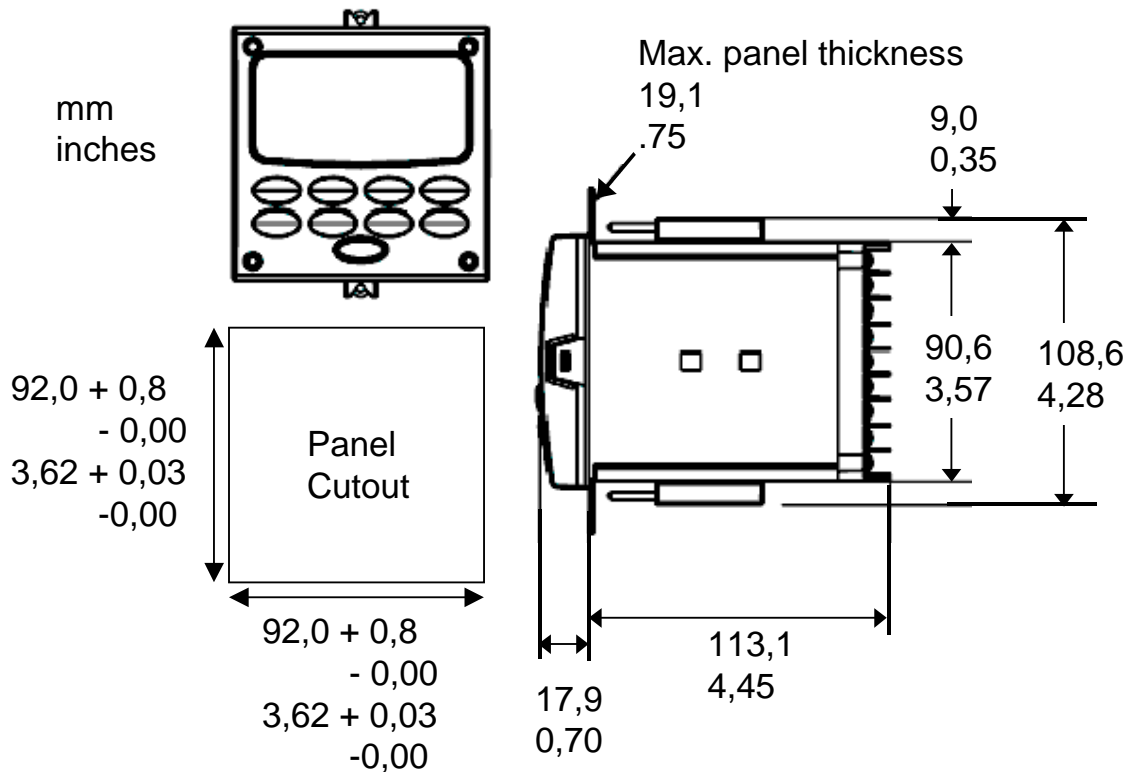

Figure 2-2 Mounting Dimensions (not to scale)

Mounting Method

Before mounting the controller, refer to the nameplate on the outside of the case and make a note of the model number. It will help later when selecting the proper wiring configuration.

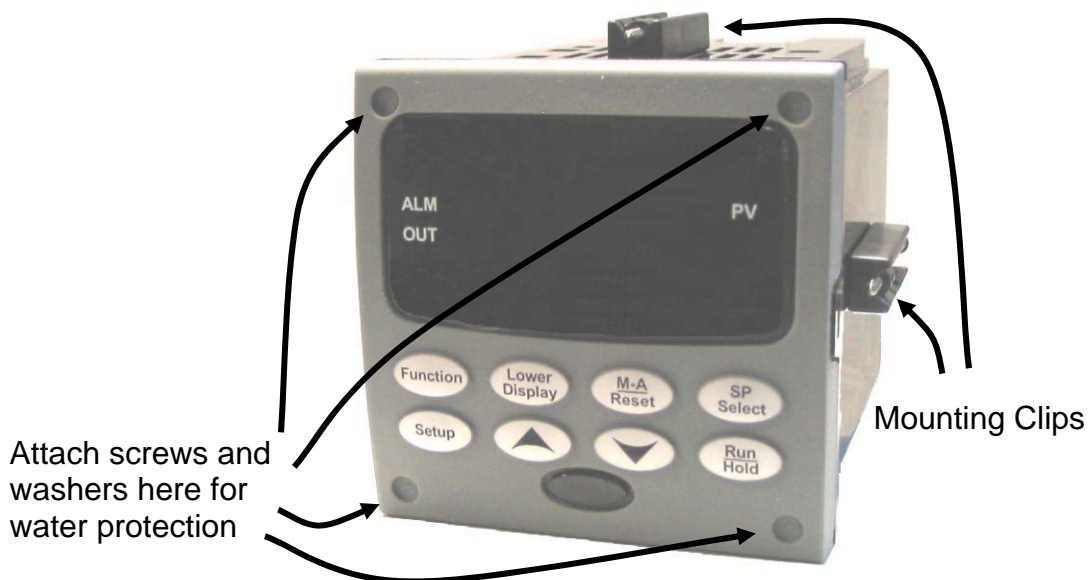

Figure 2-3 Mounting Method

Mounting Procedure

Table 2-4 Mounting Procedure

Step	Action
1	Mark and cut out the controller hole in the panel according to the dimension information in Figure 2-2.
2	Orient the case properly and slide it through the panel hole from the front.
3	Remove the mounting kit from the shipping container and install the kit as follows: <ul style="list-style-type: none"> For normal installation two mounting clips are required. Insert the prongs of the clips into the two holes in the top and bottom center of the case (Figure 2-3). For water-protected installation four mounting clips are required. There are two options of where to install the mounting clips: 1) Insert the prongs of the clips into the two holes on the left and right side of the top and bottom of the case or 2) on the center on each of the four sides (Figure 2-3). Tighten screws to 2 lb-inch (22 N•cm) to secure the case against the panel. CAUTION: Over tightening will cause distortion and the unit may not seal properly.
4	For water-protected installations, install four screws with washers into the four recessed areas in the corners of the bezel (Figure 2-3). Push the point of the screw through the center piercing the elastomeric material and then tighten screws to 5 lb-in (56 N•cm).

2.6 Wiring

2.6.1 Electrical Considerations

Line voltage wiring

This controller is considered “rack and panel mounted equipment” per EN61010-1, Safety Requirements for Electrical Equipment for Measurement, Control, and Laboratory Use, Part 1: General Requirements. Conformity with 72/23/EEC, the Low Voltage Directive requires the user to provide adequate protection against a shock hazard. The user shall install this controller in an enclosure that limits OPERATOR access to the rear terminals.

Mains Power Supply

This equipment is suitable for connection to 90 to 264 Vac or to 24 Vac/dc 50/60 Hz, power supply mains. It is the user’s responsibility to provide a switch and non-time delay (North America), quick-acting, high breaking capacity, Type F (Europe), 1/2A, 250V fuse(s), or circuit-breaker for 90-264 Vac applications; or 1 A, 125 V fuse or circuit breaker for 24 Vac/dc applications, as part of the installation. The switch or circuit-breaker shall be located in close proximity to the controller, *within easy reach of the OPERATOR*. The switch or circuit-breaker shall be marked as the disconnecting device for the controller.

CAUTION

Applying 90-264 Vac to an instrument rated for 24 Vac/dc will severely damage the instrument and is a fire and smoke hazard.

When applying power to multiple instruments, make certain that sufficient current is supplied. Otherwise, the instruments may not start up normally due to the voltage drop caused by the in-rush current.

Controller Grounding

PROTECTIVE BONDING (grounding) of this controller and the enclosure in which it is installed shall be in accordance with National and Local electrical codes. To minimize electrical noise and transients that may adversely affect the system, supplementary bonding of the controller enclosure to a local ground, using a No. 12 (4 mm²) copper conductor, is recommended.

Control/Alarm Circuit Wiring

The insulation of wires connected to the Control/Alarm terminals shall be rated for the highest voltage involved. Extra Low Voltage (ELV) wiring (input, current output, and low voltage Control/Alarm circuits) shall be separated from HAZARDOUS LIVE (>30 Vac, 42.4 Vpeak, or 60 Vdc) wiring per Permissible Wiring Bundling, Table 2-5.

Electrical Noise Precautions

Electrical noise is composed of unabated electrical signals which produce undesirable effects in measurements and control circuits.

Digital equipment is especially sensitive to the effects of electrical noise. Your controller has built-in circuits to reduce the effect of electrical noise from various sources. If there is a need to further reduce these effects:

- *Separate External Wiring*—Separate connecting wires into bundles (See Permissible Wiring Bundling - Table 2-5) and route the individual bundles through separate conduit metal trays.
- *Use Suppression Devices*—For additional noise protection, you may want to add suppression devices at the external source. Appropriate suppression devices are commercially available.

ATTENTION

For additional noise information, refer to document number 51-52-05-01, *How to Apply Digital Instrumentation in Severe Electrical Noise Environments*.

Permissible Wiring Bundling

Table 2-5 Permissible Wiring Bundling

Bundle No.	Wire Functions
1	<ul style="list-style-type: none"> • Line power wiring • Earth ground wiring • Line voltage control relay output wiring • Line voltage alarm wiring
2	<p>Analog signal wire, such as:</p> <ul style="list-style-type: none"> • Input signal wire (thermocouple, 4 to 20 mA, etc.) • 4-20 mA output signal wiring <p>Digital input signals</p>
3	<ul style="list-style-type: none"> • Low voltage alarm relay output wiring • Low voltage wiring to solid state type control circuits • Low voltage wiring to open collector type control circuits

2.7 Wiring Diagrams

Identify Your Wiring Requirements

To determine the appropriate diagrams for wiring your controller, refer to the model number interpretation in this section. The model number of the controller can be found on the outside of the case.

Wiring the Controller

Using the information contained in the model number, select the appropriate wiring diagrams from the composite wiring diagram below. Refer to the individual diagrams listed to wire the controller according to your requirements.

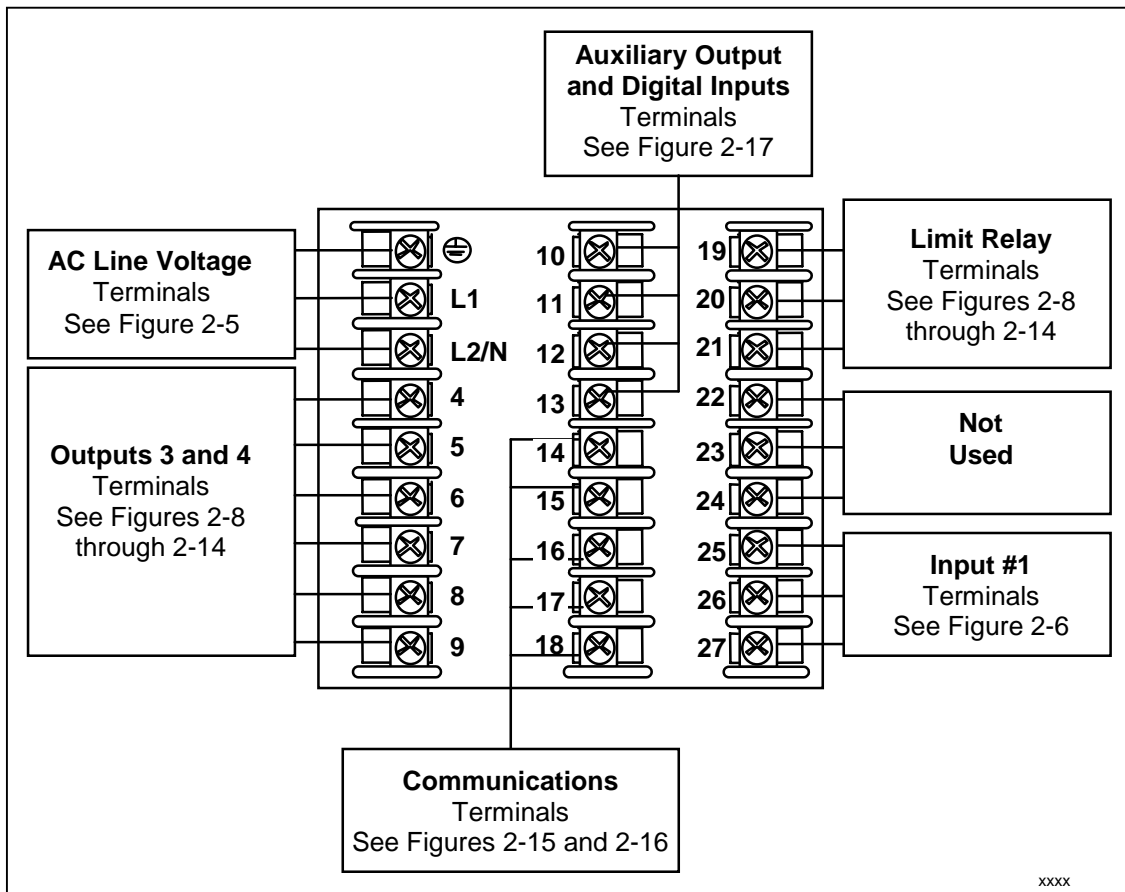

Figure 2-4 Composite Wiring Diagram

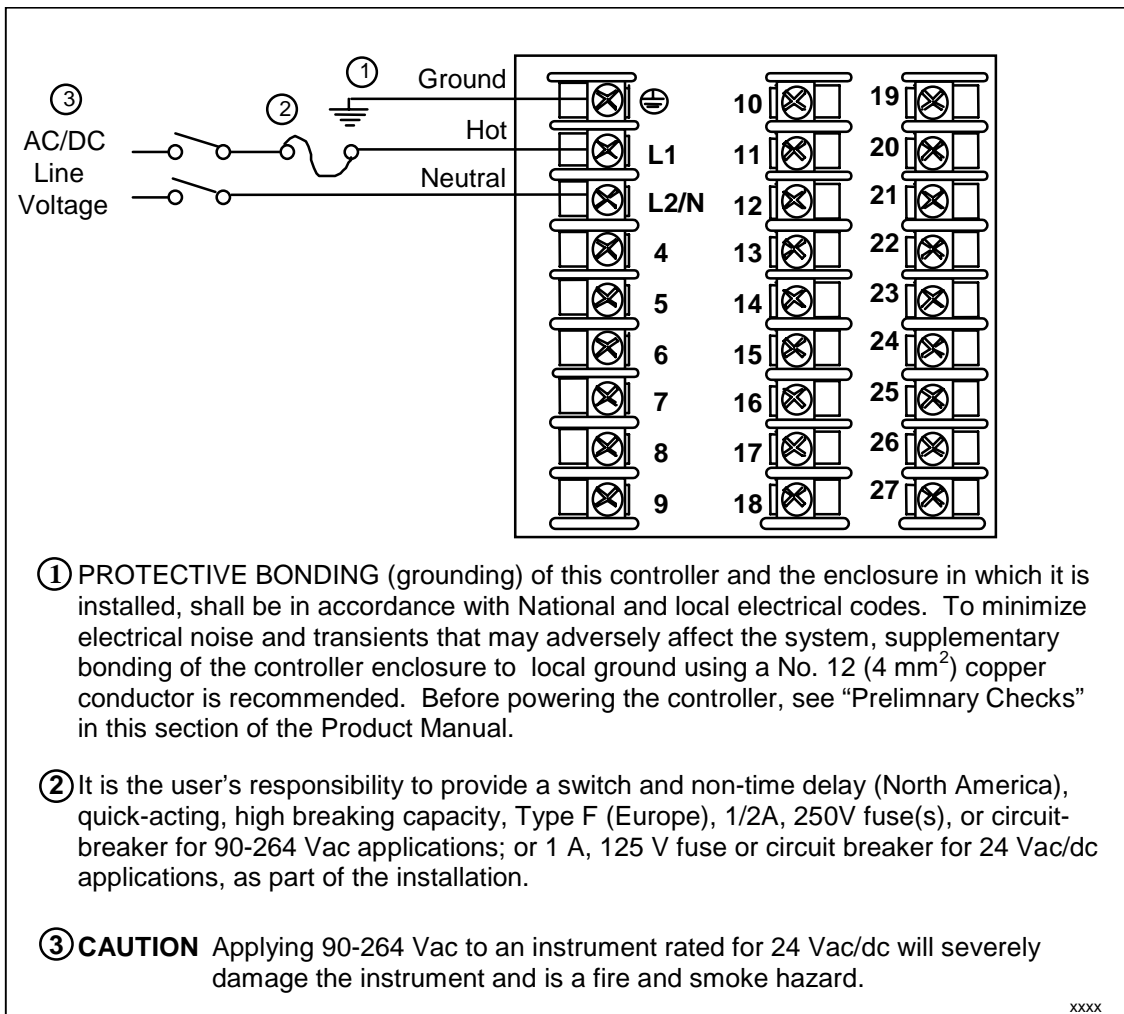

Figure 2-5 Mains Power Supply

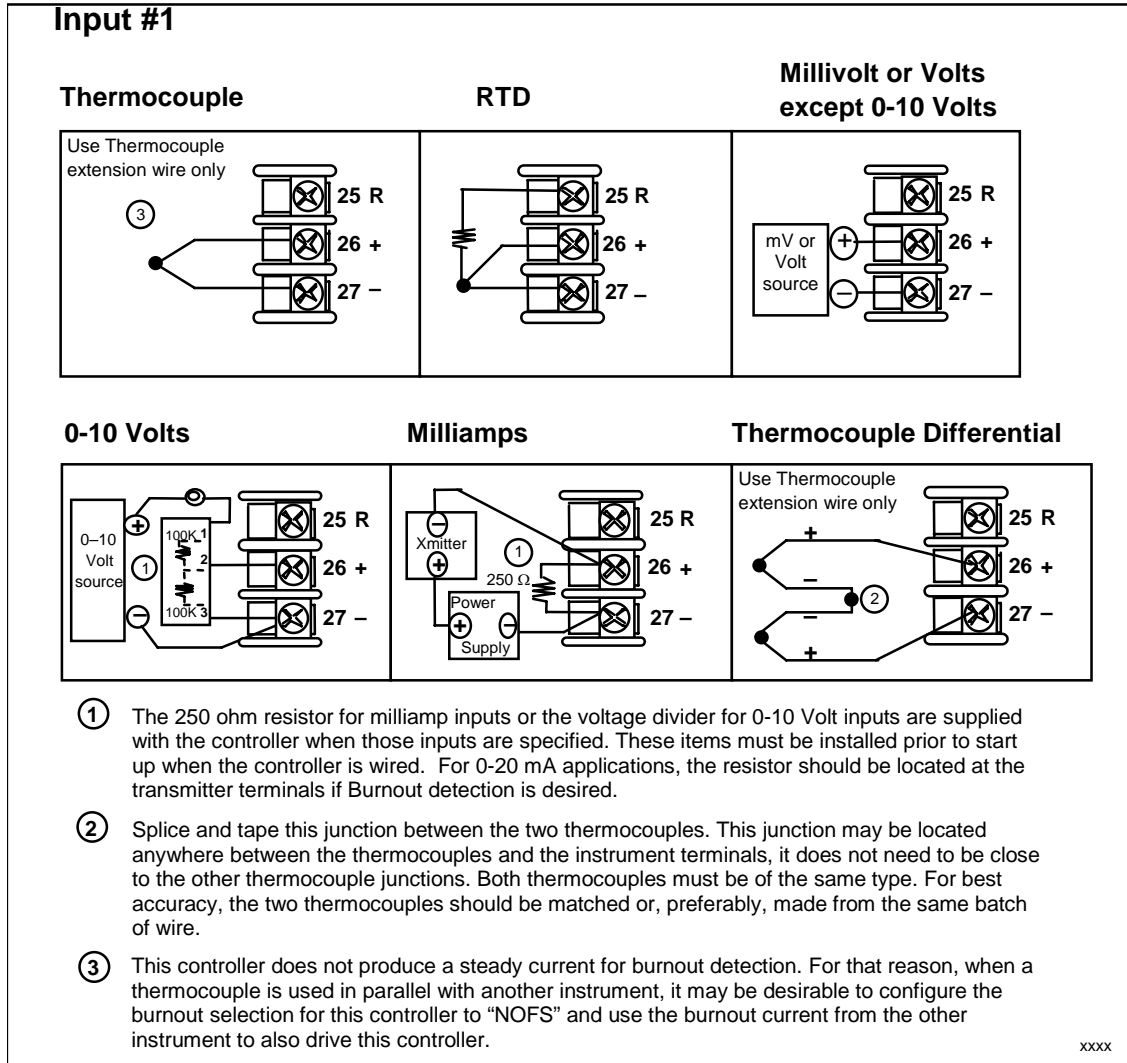

Figure 2-6 Input 1 Connections

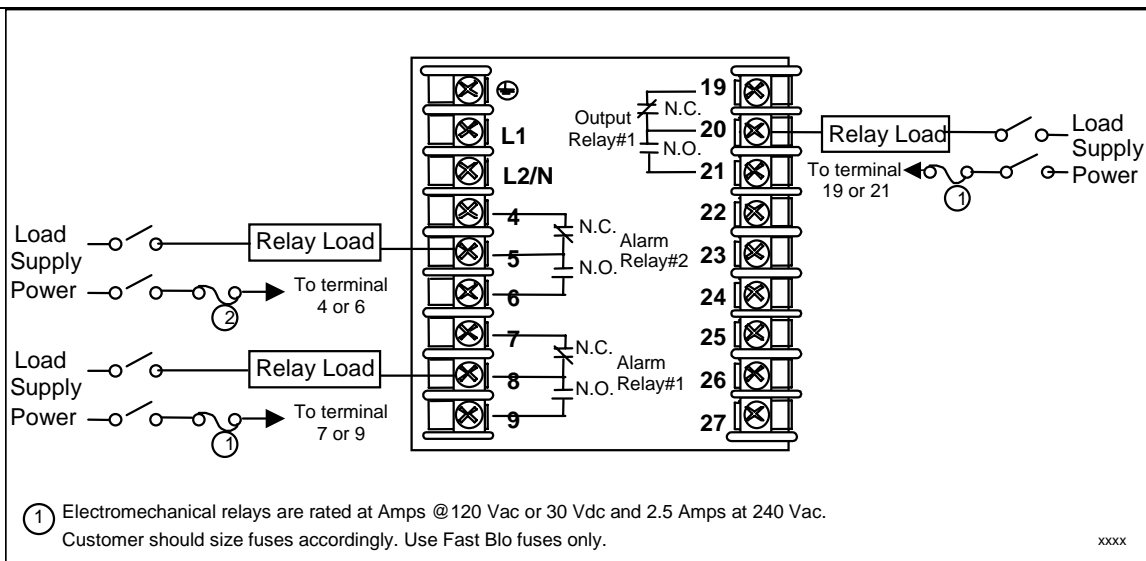

Figure 2-7 Electromechanical Relay Output

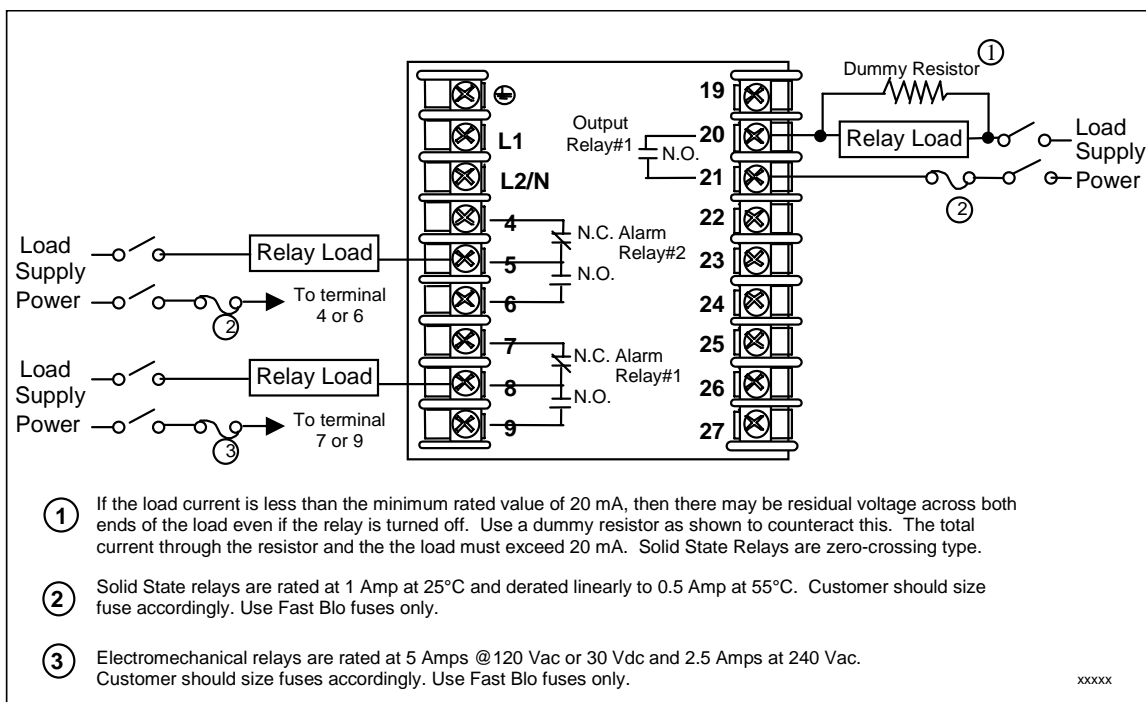

Figure 2-8 Solid State Relay Output

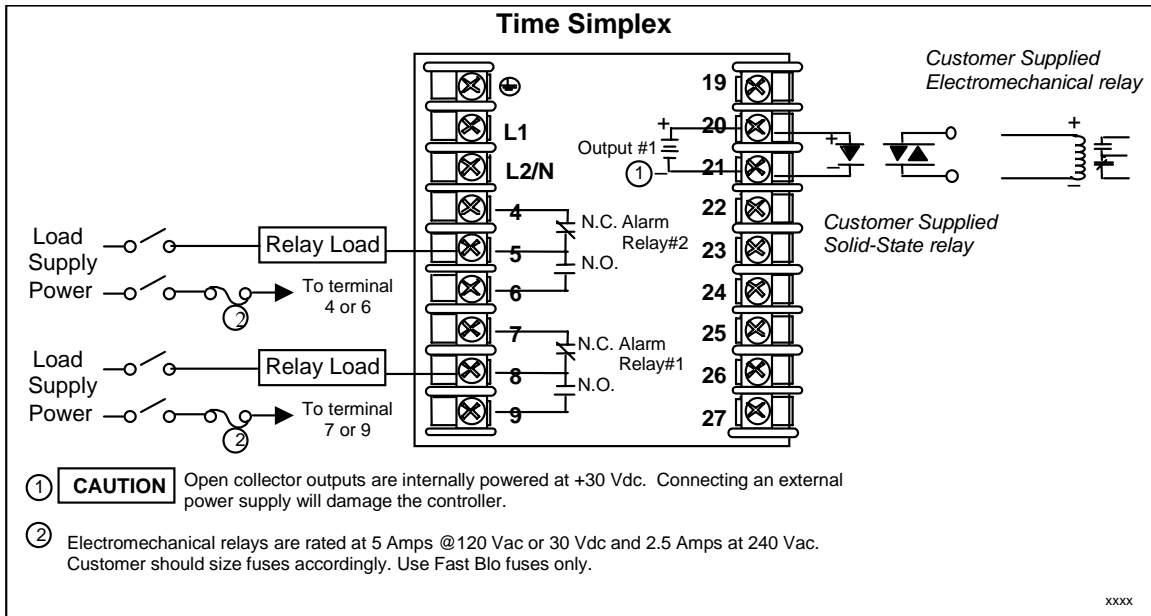

Figure 2-9 Open Collector Output

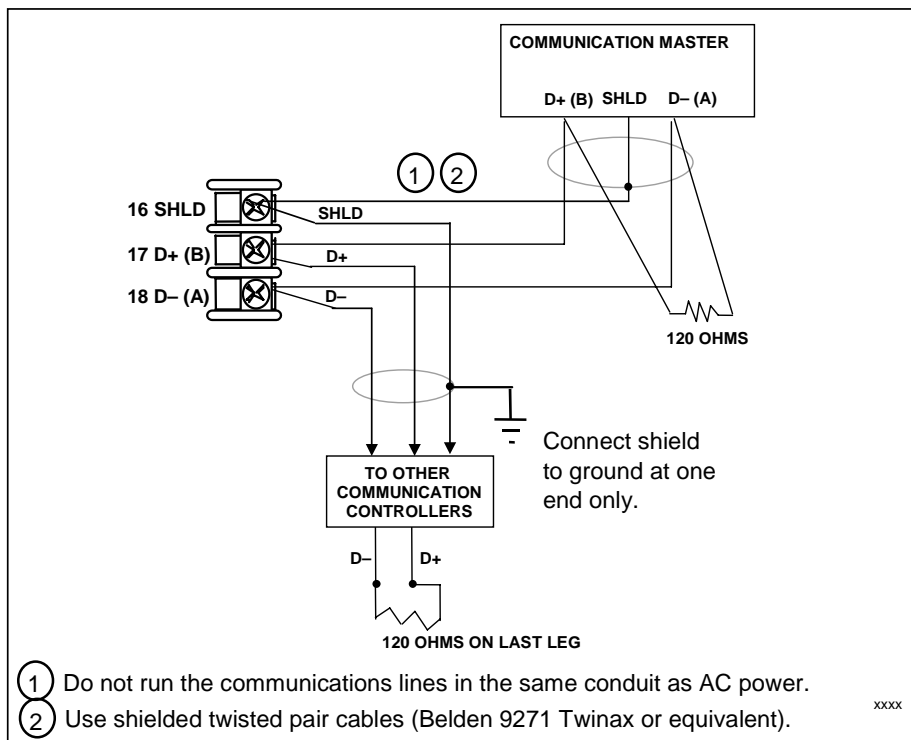

Figure 2-10 RS-422/485 Communications Option Connections

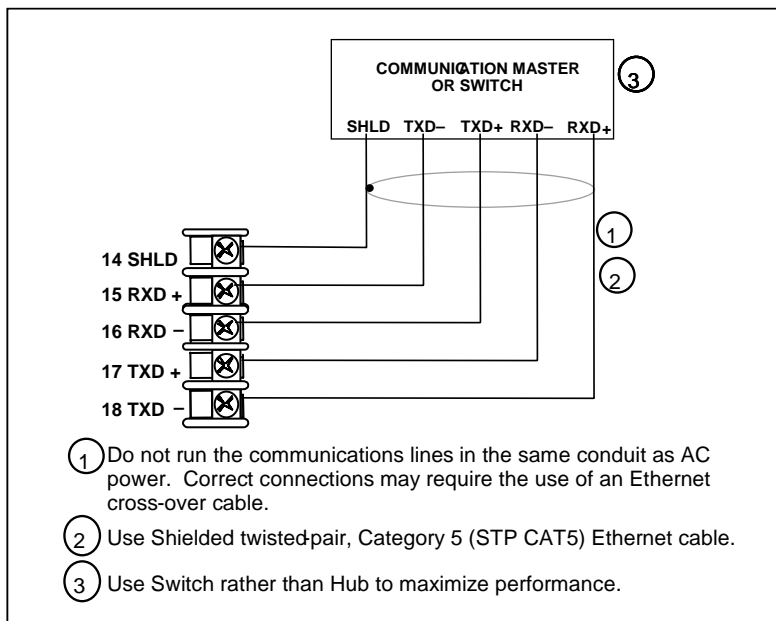

Figure 2-11 Ethernet Communications Option Connections

Figure 2-11 and Table 2-6 shows how to connect a UDC to a MDI Compliant Hub or Switch utilizing a **straight-through cable** or for connecting a UDC to a PC utilizing a **crossover cable**.

Table 2-6 Terminals for connecting a UDC to a MDI Compliant Hub or Switch

UDC Terminal	UDC Signal Name	RJ45 Socket Pin #	Switch Signal Name
Position 14	Shield	Shield	Shield
Position 15	RXD-	6	TXD-
Position 16	RXD+	3	TXD+
Position 17	TXD-	2	RXD-
Position 18	TXD+	1	RXD+

Table 2-7 shows how to connect a UDC directly to a PC utilizing a straight-through cable (wiring the UDC cable this way makes the necessary cross-over connections)

Table 2-7 Terminals for connecting a UDC directly to a PC utilizing a straight-through cable

UDC Terminal	UDC Signal Name	RJ45 Socket Pin #	PC Signal Name
Position 14	Shield	Shield	Shield
Position 15	RXD-	2	TXD-
Position 16	RXD+	1	TXD+
Position 17	TXD-	6	RXD-
Position 18	TXD+	3	RXD+

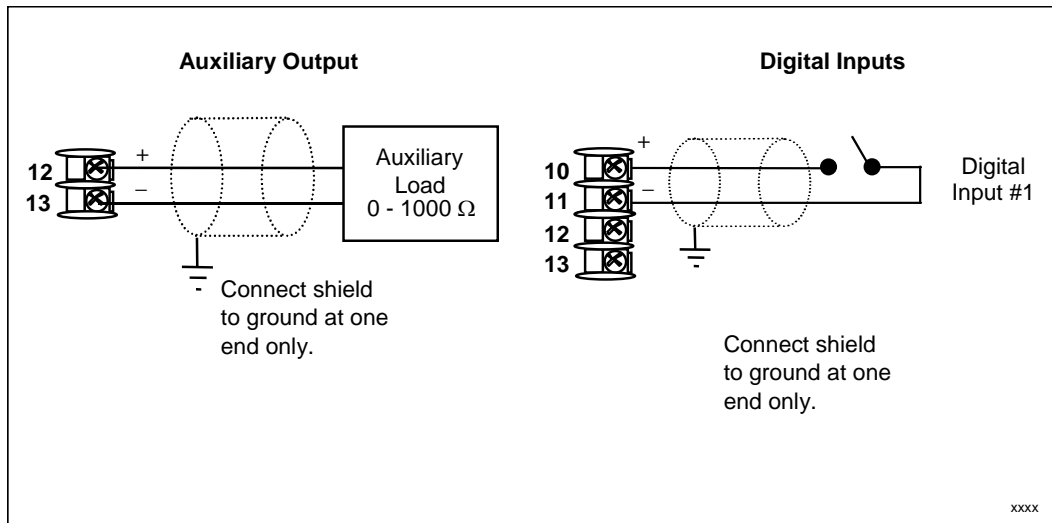

Figure 2-12 Auxiliary Output and Digital Inputs Option Connections

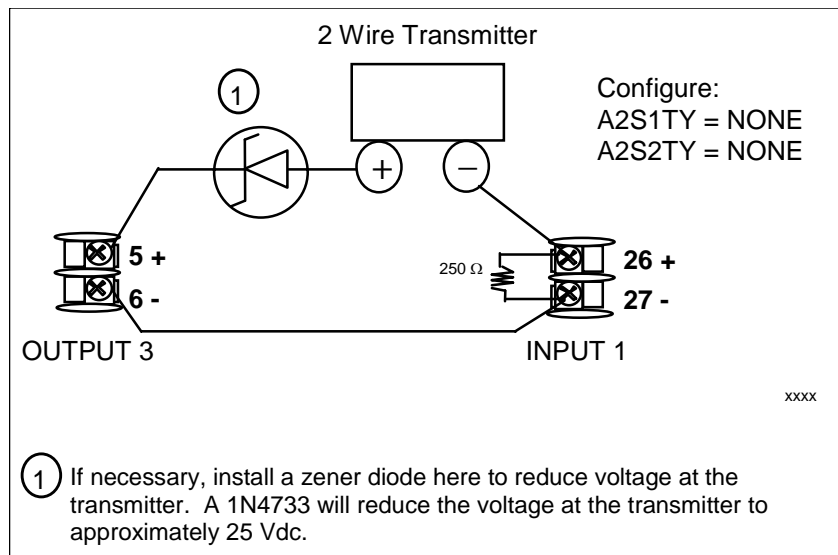

Figure 2-13 Transmitter Power for 4-20 mA — 2 wire Transmitter Using Open Collector Alarm 2 Output

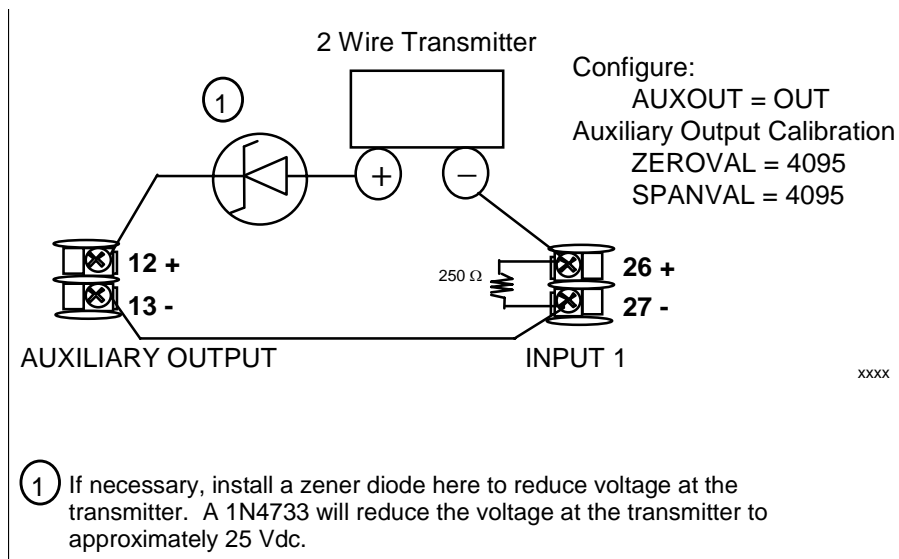

Figure 2-14 Transmitter Power for 4-20 mA — 2 Wire Transmitter Using Auxiliary Output

2.8 Limit Control Application Diagram

Limit Controller Wiring

Figure 2-15 shows the RIGHT and WRONG way to wire your Limit Controller.

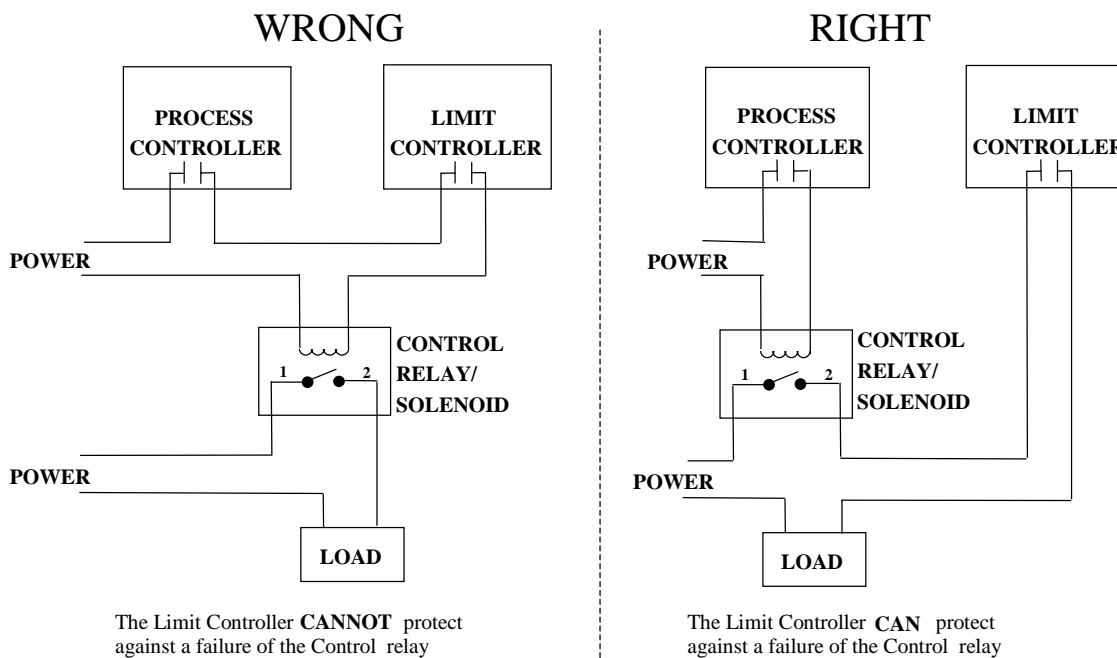

Figure 2-15 Limit Controller Application Diagram

3 Configuration

3.1 Overview

Introduction

Configuration is a dedicated operation where you use straightforward keystroke sequences to select and establish (configure) pertinent control data best suited for your application.

To assist you in the configuration process, there are prompts that appear in the upper and lower displays. These prompts let you know what group of configuration data (Set Up prompts) you are working with and also, the specific parameters (Function prompts) associated with each group.

Table 3-1 shows an overview of the prompt hierarchy as it appears in the controller.

What's in this section?

The following topics are covered in this section.

Table 3-1 Configuration Topics

TOPIC	See Page
3.1 Overview	26
3.2 Configuration Prompt Hierarchy	27
3.3 Configuration Procedure	28
3.4 Tuning Set Up Group	29
3.5 Limit Set Up Group	30
3.6 Input 1 Set Up Group	31
3.7 Options Set Up Group	35
3.8 Communications Set Up Group	37
3.9 Alarms Set Up Group	39
3.10 Display Set Up Group	43
3.11 P.I.E. Tool Ethernet and Email Configuration Screens	45
3.12 Configuration Record Sheet	48

3.2 Configuration Prompt Hierarchy

Table 3-2 Configuration Prompt Hierarchy

Set Up Group	Function Prompts
LOCK	SECUR LOCK
LIMIT	→ LOrHI POWRUP SPMAX SPMIN DISPLY
INPUT1	→ IN1TYP XMTR1 IN1 HI IN1 LO BIAS 1 FILTR1 BRNOUT EMISS
OPTIONS	DIGIN1 AUXOUT
COM	→ ComADR ComSTA IRENAB BAUD SDENAB SHDTIM BAUD TX DLY ↳ WS FLT UNITS LOOPBK
ALARMS	→ A1S1TY A1S1VA A1S1HL A1S1TY A1S1VA A1S1HL A1S1TY A1S1VA ↳ A1S1HL A1S1TY A1S1VA A1S1HL ALHYST ALARM1 BLOCK DIAGAL
DISPLY	→ DECIMAL UNITS FREQ LWRDSP TCDIAG
STATUS	VERSON FAILSF TESTS

3.3 Configuration Procedure

Introduction

Each of the Set Up groups and their functions are pre-configured at the factory. The factory settings are shown in Section 3.12. If you want to change any of these selections or values, follow the procedure in Table 3-3. This procedure tells you the keys to press to get to any Set Up group and any associated Function parameter prompt.

Procedure

ATTENTION











The prompting scrolls at a rate of 2/3 seconds when the **SET UP** or **FUNCTION** key is held in. Also,  or  keys will move group prompts forward or backward at a rate twice as fast.

Table 3-3 Configuration Procedure

Step	Operation	Press	Result
1	Enter Set Up Mode		<i>Upper Display</i> = SET <i>Lower Display</i> = LOCK (This is the first Set Up Group title)
2	Select any Set Up Group		Sequentially displays the other Set Up group titles shown in the prompt hierarchy in Table 3-2 Configuration Prompt Hierarchy. You can also use the  or  keys to scan the Set Up groups in both directions. Stop at the Set Up group title that describes the group of parameters you want to configure. Then proceed to the next step.
3	Select a Function Parameter		<i>Upper Display</i> = the current value or selection for the first function prompt of the selected Set Up group. <i>Lower Display</i> = the first Function prompt within that Set Up group. Sequentially displays the other function prompts of the Set Up group you have selected. Stop at the function prompt that you want to change, then proceed to the next step.
4	Change the Value or Selection	 or 	Increments or decrements the value or selection that appears for the selected function prompt. If you change the value or selection of a parameter while in Set Up mode then decide not to enter it, press M-A/RESET once—the original value or selection is recalled.
5	Enter the Value or Selection		Enters value or selection made into memory after another key is pressed.
6	Exit Configuration		Exits configuration mode and returns controller to the same state it was in immediately preceding entry into the Set Up mode. It stores any changes you have made. If you do not press any keys for 30 seconds, the controller times out and reverts to the mode and display used prior to entry into Set Up mode.

3.4 Lock Set Up Group

Introduction

The Lock Set Up group contains the Function parameters that will allow your controller to protect Configuration and Calibration data.

Because this group contains functions that have to do with Security and Lockout, it is best to configure this group last, after all the other configuration data has been loaded.

Function Prompts

Table 3-4 LOCK Group Function Prompts

Function Prompt Lower Display	Selection or Range of Setting Upper Display	Parameter Definition
SECUR	0 to 4095	When "LOCK" is configured as "NONE", the Security Code number is displayed and can be changed using the raise/lower keys
LOCK	NONE CAL CONF +SP	NONE – all parameters are read/write CAL - all parameters are read/write except Calibration CONF – configuration parameters are Read Only; no writes permitted +SP – Only the Lockout group is available for read/write. Setpoint value is Read Only.

3.5 Limit Set Up Group

Introduction

This data deals with the type of Limit Control you want, power up Logic, setpoint high and low limits, and the default display function Prompts

Table 3-5 LIMIT Group Function Prompts

Function Prompt Lower Display	Selection or Range of Setting Upper Display	Parameter Definition
LOorHI	LOW HIGH	LOW - Limit Control - latching relay de-energizes when PV goes below configured setpoint; cannot be reset until PV rises above configured setpoint and M-A RESET key is pressed. HIGH - Limit Control - latching relay de-energizes when PV goes above configured setpoint; cannot be reset until PV drops below configured setpoint and M-A RESET key is pressed.
POWRUP	RST NORM	RST - after power down, the controller latching relay will have to be reset. NORM - after power down, the controller will operate normally in the same mode as before power was removed unless a limit has been exceeded. If the limit was latched at power down, the unit will be in "Limit" at power up and have to be reset.
SP_MAX	0 % to 100 % of input in engineering units	HIGH SETPOINT LIMIT - this selection prevents the setpoint from going above the value selected here. The setting must be equal to or less than the upper range of the input.
SP_MIN	0 % to 100 % of input in engineering units	LOW SETPOINT LIMIT - this selection prevents the setpoint from going below the value selected here. The setting must be equal to or greater than the lower range of the input.
DISPLY	PROC SP	PROC - <i>Process Variable</i> - PV will be displayed in the upper display. SP - <i>Setpoint</i> - if configured the setpoint will be displayed in the upper display. "SP" will appear in the lower display.

3.6 Input 1 Set Up Group

Introduction

This data deals with various parameters required to configure Input 1.

Function Prompts

Table 3-6 INPUT 1 Group Function Prompts

Function Prompt Lower Display	Selection or Range of Setting Upper Display	Parameter Definition
IN1TYP	B E H E L J H J M J L K H K M K L NNMH NNML NICH NICL R S T H T L W H W L 100H 100L 200 500 RADH RADL 0-20 4-20 10m 50m 100m 0-5 1-5 0-10 TDIF PR	<p>INPUT 1 ACTUATION TYPE – This selection determines what actuation you are going to use for Input 1.</p> <p>B—B Thermocouple E H—E Thermocouple High E L—E Thermocouple Low J H—J Thermocouple High J M—J Thermocouple Med J L—J Thermocouple Low K H—K Thermocouple High K M—K Thermocouple Med K L—K Thermocouple Low NNMH—Ni-Ni-Moly Thermocouple High NNML—Ni-Ni-Moly Thermocouple Low NICH—Nicrosil-Nisil Thermocouple High NICL—Nicrosil-Nisil Thermocouple Low R—R Thermocouple S—S Thermocouple T H—T Thermocouple High T L—T Thermocouple Low W H—W5W26 Thermocouple High W L—W5W26 Thermocouple Low 100H—100 Ohm RTD High 100L—100 Ohm RTD Low 200—200 Ohm RTD 500—500 Ohm RTD RADH—Radamatic RH RADI—Radamatic RI 0-20—0 to 20 Milliamperes * 4-20—4 to 20 Milliamperes * 10m—0 to 10 Millivolts * 50m—0 to 50 Millivolts * 100m—0 to 100 Millivolts * 0-5—0 to 5 Volts * 1-5—1 to 5 Volts * 0-10—0 to 10 Volts * TDIF—Thermocouple Differential * PR—PR40-PR20 Thermocouple</p> <p>* These input types are not available on FM Models.</p>

Function Prompt Lower Display	Selection or Range of Setting Upper Display	Parameter Definition
<p>XMITR1</p>	<p>B E H E L J H J M J L K H K M K L NNMH NNML NICH NICL R S T H T L W H W L 100H 100L 200 500 RADH RADI LIN SrT</p>	<p>TRANSMITTER CHARACTERIZATION— This selection lets you instruct the controller to characterize a linear input to represent a non-linear one. If characterization is performed by the transmitter itself, then select LIN (Linear).</p> <p>ATTENTION Prompt only appears when a linear actuation is selected at prompt IN1 TYPE.</p> <p>FOR EXAMPLE: If input 1 is a 4 to 20 mA signal, but the signal represents a type K H thermocouple, then configure K H and the controller will characterize the 4 to 20 mA signal so that it is treated as a type K thermocouple input (high range).</p> <p>Parameter definitions are the same as in IN1 TYPE.</p> <p>ATTENTION Not available on FM Models.</p>
<p>IN1 HI</p>	<p>–999 to 9999 floating in engineering units</p>	<p>INPUT 1 HIGH RANGE VALUE in engineering units is displayed for all inputs but can only be configured for linear or square root transmitter characterization.</p> <p>Scale the #1 input signal to the display value you want for 100 %.</p> <p>EXAMPLE: Process Variable = Flow Range of Flow = 0 to 250 Liters/Minute Actuation (Input 1) = 4 to 20 mA Characterization (XMITTER) = LINEAR Set IN1 HI display value to 250 Set IN1 LO display value to 0 Then 20 mA = 250 Liters/Minute and 4 mA = 0 Liters/Minute</p> <p>ATTENTION The range of the Limit setpoint will be limited by the range of units selected here.</p>

Configuration

Function Prompt Lower Display	Selection or Range of Setting Upper Display	Parameter Definition
EMISS	0.01 to 1.00	EMISSIVITY is a correction factor applied to the Radiamatic input signal that is the ratio of the actual energy emitted from the target to the energy which would be emitted if the target were a perfect radiator. Available only for Radiamatic inputs.

3.7 Options Set Up Group

Introduction

The Options group lets you configure the remote mode switch (Digital Inputs) to a specific contact closure response, or configure the Auxiliary Output to be a specific selection with desired scaling.

Function Prompts

Table 3-7 OPTION Group Function Prompts

Function Prompt Lower Display	Selection or Range of Setting Upper Display	Parameter Definition
AUXOUT	<p>NONE</p> <p>PROC</p> <p>DEV</p>	<p>AUXILIARY OUTPUT SELECTION This selection provides an mA output representing one of several control parameters. The display for auxiliary output viewing will be in engineering units for all but output. Output will be displayed in percent.</p> <p>ATTENTION Other prompts affected by these selections: 4mA VAL and 20mA VAL.</p> <p>ATTENTION Output cannot be configured when Three Position Step Control is used.</p> <p>NO AUXILIARY OUTPUT</p> <p>PROCESS VARIABLE—Represents the value of the Process Variable. PV = Input XxRatioX + BiasX</p> <p>DEVIATION (PROCESS VARIABLE MINUS SETPOINT)—Represents -100 % to +100 % of the selected PV span in engineering units.</p> <p>Zero deviation will produce a center scale (12 mA or 50 %) output. A negative deviation equal in magnitude to the Auxiliary Output High Scaling Factor will produce a low end output (4 mA or 0 %) output. A positive deviation equal in magnitude to the Auxiliary Output Low Scaling Factor will produce a high end output (20 mA or 100 %).</p> <p>FOR EXAMPLE: Input 1 = Type T High Thermocouple PV range = -300 °F to +700 °F PV span = 1000 °F Deviation Range = -1000 °F to +1000 °F Auxiliary Output Low Scale Value = 0.0 Auxiliary Output High Scale Value = 1000 If PV = 500 °F and SP = 650 °F then Deviation Display = -150 °F, which is -7.5% of the Deviation Range, so Auxiliary Output = 50% - 7.5% = 42.5%</p>

Function Prompt Lower Display	Selection or Range of Setting Upper Display	Parameter Definition
0_PCT	Value in Engineering Units	<p>AUXILIARY OUTPUT LOW SCALING FACTOR—Use a value in engineering units to represent all AUX OUT parameters except output.</p> <p>Use value in percent (%) for output. (Output can be between –5 % and +105 %.)</p>
100 PCT	Value in Engineering Units	<p>AUXILIARY OUTPUT HIGH SCALING FACTOR—Use a value in engineering units to represent all AUX OUT parameters except output.</p> <p>Use a value in percent (%) for Output. (Output can be between –5 % and +105 %.)</p>
CRANGE	4-20 0-20	<p>AUXILIARY OUTPUT RANGE allows the user to easily select 4-20mA output or 0-20mA output operation without the need for recalibration of the instrument.</p> <p>ATTENTION Changing the Auxiliary Output Range will result in the loss of Field Calibration values and will restore Factory Calibration values.</p>
DIGIN1	DIS ENAB	<p>DIGITAL INPUT 1 SELECTIONS—All selections are available for Input 1. The controller returns to its original state when contact opens, except when overruled by the keyboard.</p> <p>EXTERNAL RESET (DIGITAL INPUT) — resets the latching relay on contact closure.</p> <p>DIS – Disable</p> <p>ENAB – Enable</p>

3.8 Communications Set Up Group

Introduction

The Communications group lets you configure the controller to be connected to a host computer via Modbus® or Ethernet TCP/IP protocol.

Introduction

A controller with a communications option looks for messages from the host computer. If these messages are not received within the configured shed time, the controller will SHED from the communications link and return to stand-alone operation. You can also set the SHED output mode and setpoint recall, and communication units.

Up to 99 addresses can be configured over this link. The number of units that can be configured depends on the link length, with 31 being the maximum for short link lengths and 15 drops being the maximum at the maximum link length.

ATTENTION

FM Models cannot have parameters changed (write transactions) via communications, parameters can only be changed via the keyboard.

Function Prompts

Table 3-8 Communications Group Function Prompts

Function Prompt Lower Display	Selection or Range of Setting Upper Display	Parameter Definition
ComADR	1 to 99	COMMUNICATIONS STATION ADDRESS —This is a number that is assigned to a controller that is to be used with the communications option. This number will be its address. This parameter is also used for the IR communications link.
COMSTA	DIS MODB ETHR	COMMUNICATIONS SELECTION DISABLE —Disables the communications option. MODBUS —Enable Modbus RTU communications ETHERN —Enable Ethernet communications
IRENAB	DIS EnAB	INFRARED COMMUNICATIONS – Enables/Disables the IR Port.
BAUD	4800 9600 19200 38400	BAUD RATE is the transmission speed in bits per second. 4800 BAUD 9600 BAUD 19200 BAUD 38400 BAUD

Function Prompt Lower Display	Selection or Range of Setting Upper Display	Parameter Definition																								
TX_DLY	1 to 500 milliseconds	TX DELAY —Configurable response-delay timer allows you to force the UDC to delay its response for a time period of from 1 to 500 milliseconds compatible with the host system hardware/software. This parameter is also used for the IR communications link.																								
WS_FLT	 FP B FPBB FP L FPLB	Defines word/byte order of floating point data for communications. Byte values: <table style="margin-left: 40px; border-collapse: collapse;"> <tr> <td style="padding: 0 10px;">0</td> <td style="padding: 0 10px;">1</td> <td style="padding: 0 10px;">2</td> <td style="padding: 0 10px;">3</td> </tr> <tr> <td style="padding: 0 10px;">s</td> <td style="padding: 0 10px;">e</td> <td style="padding: 0 10px;">m</td> <td style="padding: 0 10px;">m</td> </tr> </table> Where: s = sign, e = exponent, m = mantissa bit <table style="margin-left: 40px; border-collapse: collapse;"> <tr> <td style="padding: 0 10px;">0</td> <td style="padding: 0 10px;">1</td> <td style="padding: 0 10px;">2</td> <td style="padding: 0 10px;">3</td> </tr> <tr> <td style="padding: 0 10px;">1</td> <td style="padding: 0 10px;">0</td> <td style="padding: 0 10px;">3</td> <td style="padding: 0 10px;">2</td> </tr> <tr> <td style="padding: 0 10px;">3</td> <td style="padding: 0 10px;">2</td> <td style="padding: 0 10px;">1</td> <td style="padding: 0 10px;">0</td> </tr> <tr> <td style="padding: 0 10px;">2</td> <td style="padding: 0 10px;">3</td> <td style="padding: 0 10px;">0</td> <td style="padding: 0 10px;">1</td> </tr> </table>	0	1	2	3	s	e	m	m	0	1	2	3	1	0	3	2	3	2	1	0	2	3	0	1
0	1	2	3																							
s	e	m	m																							
0	1	2	3																							
1	0	3	2																							
3	2	1	0																							
2	3	0	1																							
SDENAB	DIS EnAB	SHED ENABLE —Disables/enables shed functionality.																								
SHDTIM	0 to 255 Sample Periods	SHED TIME —The number that represents how many sample periods there will be before the controller sheds from communications. Each period equals 1/3 seconds; 0 equals No shed. Note: If ComSTA is set to MODBUS and if SHEDENAB is set to DISABL, Shed Time will not be configurable.																								
UNITS	PCT EGR	PERCENT ENGINEERING UNITS																								
LOOPBK	DIS ENAB	LOCAL LOOPBACK tests the communications hardware. DISABLE —Disables the Loopback test. ENABLE —Allows loopback test. The UDC goes into Loopback mode in which it sends and receives its own message. The UDC displays PASS or FAIL status in the upper display and LOOPBACK in the lower display while the test is running. The UDC will go into manual mode when LOOPBACK is enabled with the output at the Failsafe value. The test will run until the operator disables it here, or until power is turned off and on. ATTENTION The instrument does not have to be connected to the external communications link in order to perform this test. If it is connected, only one instrument should run the loopback test at a time. The host computer should not be transmitting on the link while the loopback test is active.																								

3.9 Alarms Set Up Group

Introduction

An alarm is an indication that an event that you have configured (for example—Process Variable) has exceeded one or more alarm limits. There are two alarms available. Each alarm has two setpoints. You can configure each of these two setpoints to alarm on various controller parameters.

There are two alarm output selections, High and Low. You can configure each setpoint to alarm either High or Low. These are called single alarms.

You can also configure the two setpoints to alarm on the same event and to alarm both high and low. A single adjustable Hysteresis of 0 % to 100 % is configurable for the alarm setpoint.

See Table 2-3 in the Installation section for Alarm relay contact information.

The prompts for the Alarm Outputs appear whether or not the alarm relays are physically present. This allows the Alarm status to be shown on the display and/or sent via communications to a host computer.

Function Prompts

Table 3-9 ALARMS Group Function Prompts

Function Prompt Lower Display	Selection or Range of Setting Upper Display	Parameter Definition
A1S1TY	<p>NONE PROC DE SHED FSAF PrRT DI TC W TC F</p>	<p>ALARM 1 SETPOINT 1 TYPE—Select what you want Setpoint 1 of Alarm 1 to represent. It can represent the Process Variable, Deviation, Input 1, Input 2, Output, and if you have a model with communications, you can configure the controller to alarm on SHED. If you have setpoint programming, you can alarm when a segment goes ON or OFF.</p> <p>NO ALARM PROCESS VARIABLE DEVIATION SHED FROM COMMUNICATIONS FAILSAFE PV RATE OF CHANGE DIGITAL INPUT 1 ACTUATED THERMOCOUPLE WARNING (NOTE 1) THERMOCOUPLE FAILING (NOTE 2)</p> <p>ATTENTION</p> <p>NOTE 1. Thermocouple Warning means that the instrument has detected that the Thermocouple Input is starting to fail. Not valid for input types other than Thermocouple.</p>
		<p>NOTE 2. Thermocouple Failing means that the instrument has detected that the</p>

Function Prompt Lower Display	Selection or Range of Setting Upper Display	Parameter Definition
		Thermocouple Input is in imminent danger of failing. Not valid for input types other than Thermocouple.
A1S1VA	Value in engineering units	<p>ALARM 1 SETPOINT 1 VALUE—This is the value at which you want the alarm type chosen in prompt A1S1TYPE to actuate. The value depends on what the setpoint has been configured to represent. No setpoint is required for alarms configured for Communications SHED.</p> <p>This prompt does not appear for Alarm Types that do not use values. For example: A1S1TY = MANUAL.</p>
A1S1HL	HIGH LOW	<p>ALARM 1 SETPOINT 1 STATE—Select whether you want the alarm type chosen in prompt A1S1TYPE to alarm High or Low.</p> <p>HIGH ALARM LOW ALARM</p>
A1S2TY		<p>ALARM 1 SETPOINT 2 TYPE—Select what you want Setpoint 2 of Alarm 1 to represent.</p> <p>The selections are the same as A1S1TYPE.</p>
A1S2VA	Value in engineering units	<p>ALARM 1 SETPOINT 2 VALUE—This is the value at which you want the alarm type chosen in prompt A1S2TYPE to actuate.</p> <p>The details are the same as A1S1 VAL.</p>
A1S2HL	HIGH LOW	<p>ALARM 1 SETPOINT 2 STATE—Same as A1S1HL.</p>
A2S1TY		<p>ALARM 2 SETPOINT 1 TYPE—Select what you want Setpoint 1 of Alarm 2 to represent.</p> <p>The selections are the same as A1S1TYPE.</p> <p>ATTENTION Not applicable with Relay Duplex unless using Dual Relay PWA.</p>
A2S1VA	Value in engineering units	<p>ALARM 2 SETPOINT 1 VALUE—This is the value at which you want the alarm type chosen in prompt A2S1TYPE to actuate.</p> <p>The details are the same as A1S1 VAL.</p>
A2S1HL	HIGH LOW	<p>ALARM 2 SETPOINT 1 STATE—Same as A1S1HL.</p>

Function Prompt Lower Display	Selection or Range of Setting Upper Display	Parameter Definition
A2S2TY	Value in engineering units	<p>ALARM 2 SETPOINT 2 TYPE—Select what you want Setpoint 2 of Alarm 2 to represent.</p> <p>The selections are the same as A1S1TYPE.</p> <p>ATTENTION Not applicable with Relay Duplex unless using Dual Relay PWA.</p>
A2S2VA		<p>ALARM 2 SETPOINT 2 VALUE—This is the value at which you want the alarm type chosen in prompt A2S2TYPE to actuate.</p> <p>The details are the same as A1S1 VAL.</p>
A2S1HL	HIGH LOW	<p>ALARM 2 SETPOINT 1 STATE—Same as A1S1HL.</p>
ALHYST	0.0 to 100.0 % of span or full output as appropriate	<p>ALARM HYSTERESIS—A single adjustable hysteresis is provided on alarms such that when the alarm is OFF it activates at exactly the alarm setpoint; when the alarm is ON, it will not deactivate until the variable is 0.0 % to 100 % away from the alarm setpoint.</p> <p>Configure the hysteresis of the alarms based on INPUT signals as a % of input range span.</p> <p>Configure the hysteresis of the alarm based on OUTPUT signals as a % of the full scale output range.</p>
ALARM1	NO LAT LATCH	<p>LATCHING ALARM OUTPUT 1—Alarm output 1 can be configured to be Latching or Non-latching.</p> <p>NO LAT—Non-latching LATCH—Latching</p> <p>ATTENTION When configured for latching, the alarm will stay active after the alarm condition ends until the RUN/HOLD key is pressed.</p>

Function Prompt Lower Display	Selection or Range of Setting Upper Display	Parameter Definition
BLOCK	DIS AL1 AL 2 AL12	<p>ALARM BLOCKING—Prevents nuisance alarms when the controller is first powered up. The alarm is suppressed until the parameter gets to the non-alarm limit or band. Alarm blocking affects both alarm setpoints.</p> <p>DISABLE—Disables blocking AL 1—Blocks alarm 1 only AL 2—Blocks alarm 2 only AL12—Blocks both alarms</p> <p>ATTENTION When enabled on power up or initial enabling via configuration, the alarm will not activate unless the parameter being monitored has not been in an alarm condition for a minimum of one control cycle (167 ms).</p>
DIAGAL	DIS AL 1 AL 2 DISWRN	<p>DIAGNOSTIC—Monitors the Current Output and/or Auxiliary Output for an open circuit condition. If either of these two outputs falls below about 3.5 mA, then an Alarm is activated. This configuration is in addition to whatever was selected for AxSxTYPE.</p> <p>DISABLE—Disables Diagnostic Alarm ALARM 1—Alarm 1 is diagnostic alarm ALARM 2—Alarm 2 is diagnostic alarm DISABLE WARNING—Disables Output Fail message on lower display</p>

3.10 Display Set Up Group

Introduction

This group includes selections for Decimal place, Units of temperature, Language and Power frequency.

Function Prompts

Table 3-10 DISPLY Group Function Prompts

Function Prompt Lower Display	Selection or Range of Setting Upper Display	Parameter Definition
DECMAL	NONE ONE TWO	<p>DECIMAL POINT LOCATION—This selection determines where the decimal point appears in the display.</p> <p>NONE—No Decimal Place—fixed, no auto-ranging ONE—888.8 TWO—88.88</p> <p>ATTENTION Auto-ranging will occur for selections of one or two decimal places. For example, should the instrument be configured for two decimal places and the PV exceeds 99.99, then the display will change to a single decimal place so that values of 100.0 and above can be shown.</p>
UNITS	F C NONE	<p>TEMPERATURE UNITS—This selection will affect the indication and operation.</p> <p>DEG F—Degrees Fahrenheit DEG C—Degrees Centigrade NONE—No display of units</p>
FREQ	60 50	<p>POWER LINE FREQUENCY—Select whether your controller is operating at 50 or 60 Hertz.</p> <p>ATTENTION For controllers powered by +24 Vdc, this configuration should be set to the AC line frequency used to produce the +24 Vdc supply.</p> <p>Incorrect setting of this parameter can cause normal mode noise problems in the input readings.</p>
LWRDSP	ENAB DIS	<p>LOWER DISPLY—Select whether the unit uses single or dual display.</p> <p>ENAB—Enable Dual Display DIS—Disable Dual Display (Single Display Only)</p>

Configuration

Function Prompt Lower Display	Selection or Range of Setting Upper Display	Parameter Definition
TCDIAG	ENAB DIS	THERMOCOUPLE DIAGNOSTICS —Enable or disable Thermocouple diagnostic messages. ENAB —Enable Diagnostic Messages DIS —Disable Diagnostic Messages

3.11 P.I.E. Tool Ethernet and Email Configuration Screens

Introduction

These screens only appear in instruments that have Ethernet Communications. Ethernet and Email parameters can only be configured via the Process Instrument Explorer (P.I.E. Tool[®]). The figures in this section show screen-shots of the Configuration Screens from the PC version of the P.I.E. Tool[®]. Pocket PC Configuration Screens are generally similar in format but smaller.

Ethernet Configuration Screen

This controller is shipped from the factory with the IP Address set to 10.0.0.2, the Subnet Mask set to 255.255.255.0 and the Default Gateway set to 0.0.0.0. Consult your Information Technologies (IT) representative as to how these should be configured for your installation. The MAC address is printed on the product label located on the instrument's case.

These settings can be changed via the Ethernet Configuration Screen as shown in Figure 3-1.

See Section 4.9 – *Configuring your Ethernet Connection* for more information.

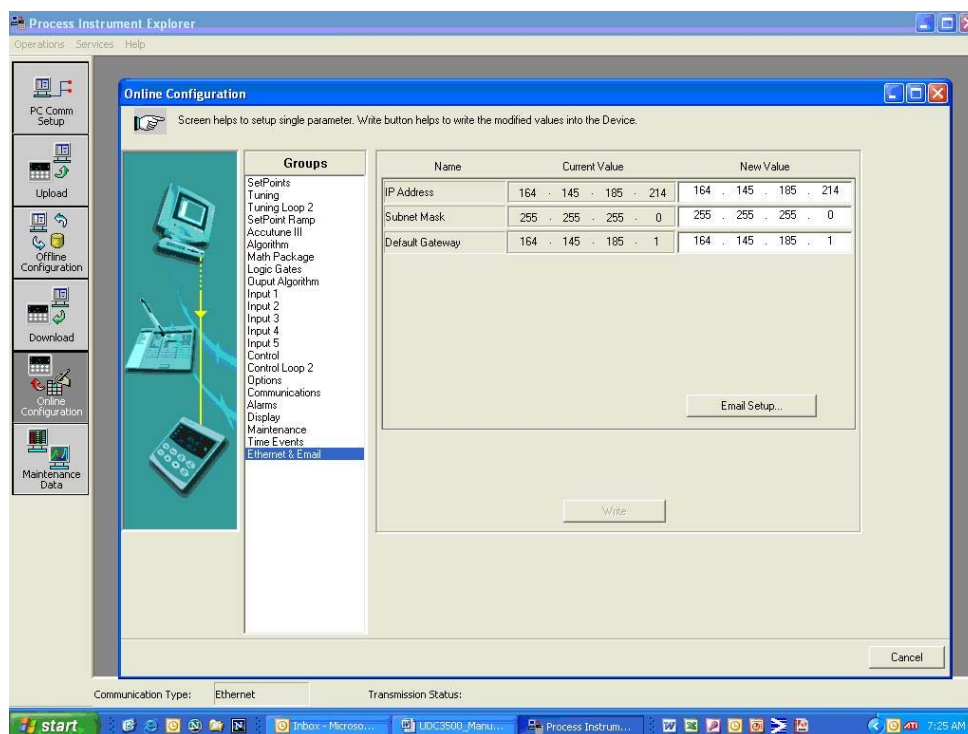

Figure 3-1 Ethernet Configuration Screen

WARNING

After you change the IP Address, you will no longer be able to communicate with the instrument via Ethernet until you change the P.I.E. Tool's IP Address setting in the "PC COMM SETUP" to match the setting that is now in your controller.

Email Configuration Screen

This controller may be configured to support up to two Emails. Each Email can be sent to a different address. Emails are sent only when the selected alarm transitions from the OFF to the ON state.

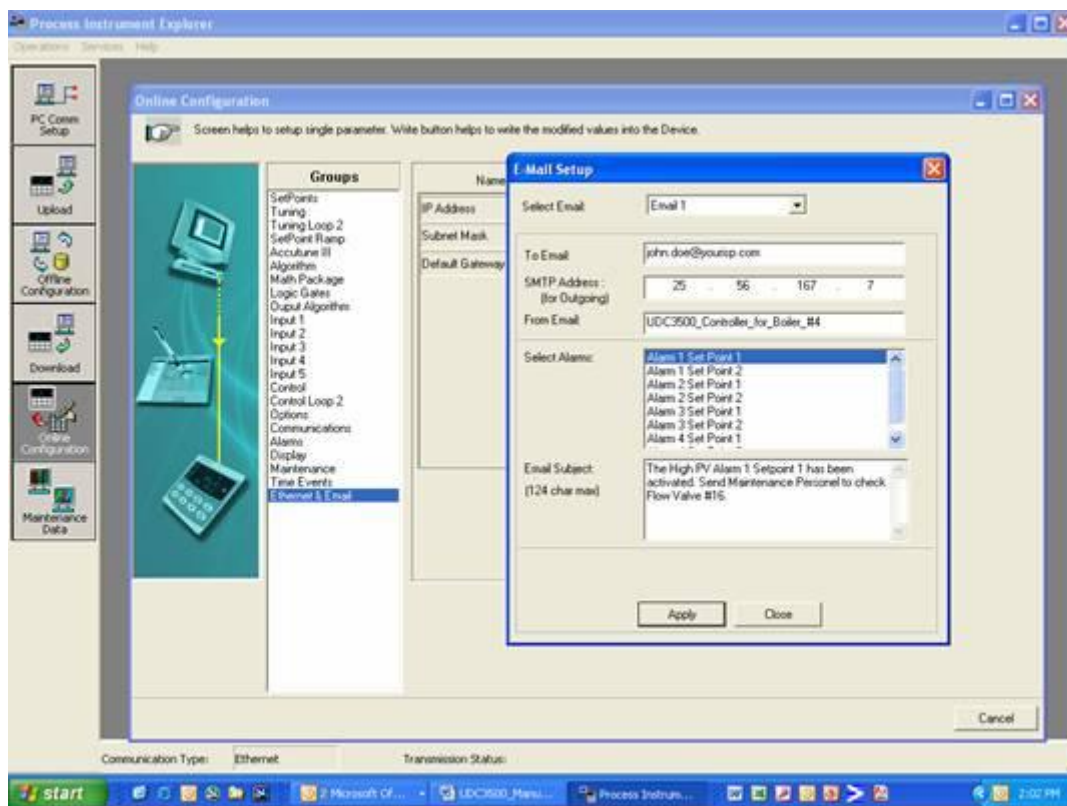

Figure 3-2 Email Configuration Screen

This controller cannot receive Emails, so it is suggested that you configure the "From Email:" window with a non-Email style address that will make it easy for you to determine which controller sent the Email. For Email technical reasons, the entry in the "From Email:" window cannot have spaces. See Figure 3-2.

If you do not know your SMTP IP Address for outgoing Email, then contact your Information Technologies (IT) representative. If your PC is on the same LAN that will be used by the controller and which also connects to the Email server, then the SMTP IP Address may generally be found by opening a DOS shell and typing:

ping smtp.[your domain name and extension], i.e., "ping smtp.your_isp.com"

The content of the Emails sent by this controller contains the Alarm that triggered the Email, its settings and the current value (if applicable) of the monitored variable. For example, the content of an Email triggered by Alarm 1 Setpoint 1 that is configured to monitor Input 1 would look something like this:

Name: Alarm 1 SP1, Type: INPUT1, Event: HIGH/END, Value = 500.00,
Actual = 712.69

The content of an Email triggered by Alarm 2 Setpoint 1 that is configured to monitor Digital Input 1 would look something like this:

Name: Alarm 2 SP1, Type: DIG IN1, Event: HIGH/END, Value = 0.00,
Actual = 0.00

ATTENTION

Email will always be time-stamped with the date that the Ethernet Software in the instrument was last modified.

If the SMTP address on your network is changed, such as can happen when a server is replaced, then you must reconfigure the Email SMTP IP address in this instrument to match.

3.12 Configuration Record Sheet

Enter the value or selection for each prompt on this sheet so you will have a record of how your controller was configured.

Group Prompt	Function Prompt	Value or Selection	Factory Setting	Group Prompt	Function Prompt	Value or Selection	Factory Setting	
LOCK	SECUR	_____	DIS	COM	ComADR	_____	3	
	LOCK	_____	CAL		ComSTA	_____	DIS	
LIMIT	LOW or	_____	HIGH NORM 1000 0 PROC		IRENAB	_____	ENAB	
	HIGH	_____			SDENAB	_____	ENAB	
	POWRUP	_____			SHDTIM	_____	10	
	SP MAX	_____			BAUD	_____	19200	
	SP MIN	_____			TX DLY	_____	30	
DISPLY	_____	0	WS FLT		_____	FP_B		
			PROC		UNITS	_____	PCT	
					LOOPBK	_____	DIS	
INPUT1	IN1TYP	_____	KH	ALARMS	A1S1TY	_____	NONE	
	XMITR1	_____	LIN		A1S1VA	_____	90	
	IN1 HI	_____	2400		A1S1HL	_____	HIGH	
	IN1 LO	_____	1.00		A1S2TY	_____	NONE	
	BIAS 1	_____	0.0		A1S2VA	_____	90	
	FILTR1	_____	1.0		A1S2HL	_____	HIGH	
	BRNOUT	_____	UP		A2S1TY	_____	NONE	
	EMIS	_____	1.0		A2S1VA	_____	90	
	FREQ	_____	60		A2S1HL	_____	HIGH	
	DISPLY	_____	SP		A2S2TY	_____	NONE	
OPTIONS	AUXOUT	_____	DIS	A2S2VA	_____	90		
	0 PCT	_____	0	A2S2HL	_____	HIGH		
	100 PCT	_____	100	ALHYST	_____	0.1		
	CRANGE	_____	4-20	ALARM1	_____	NOL		
	DIGIN1	_____	DIS	BLOCK	_____	DIS		
				DIAGAL	_____	DIS		
					DISPLY	DECML	_____	NONE
						UNITS	_____	F
						FREQ	_____	60
						LWRDSP	_____	ENAB
				TCDIAG		_____	ENAB	

4 Operating the Limit Controller

4.1 Overview

Introduction

This section gives you all the information necessary to help you monitor your controller including an Operator Interface overview, how to lockout changes to the controller, entering a security code, and monitoring the displays.

What's in this section?

The following topics are covered in this section.

TOPIC	See Page
4.1 Overview	49
4.2 Operator Interface	50
4.3 Entering A Security Code	50
4.4 Lockout Feature	51
4.5 Monitoring The Limit Controller	52
4.6 How to Operate Your Limit Controller	54
4.7 Alarm Setpoints	57
4.8 P.I.E. Tool Maintenance Screens	58
4.9 Configuring your Ethernet Connection	64

4.2 Operator Interface

Introduction

Figure 5-1 is a view of the Operator Interface. A description of the displays and indicators is included.



Figure 4-1 Operator Interface

4.3 Entering a Security Code

Introduction

The level of keyboard lockout may be changed in the Set Up mode. However, knowledge of a security code number (0 to 9999) may be required to change from one level of lockout to another. When a controller leaves the factory, it has a security code of 0, which permits changing from one lockout level to another without entering any other code number.





Procedure

If you require the use of a security code, select a number from 0001 to 9999 and enter it when the lockout level is configured as NONE. Thereafter, that selected number must be used to change the lockout level from something other than NONE.

NOTICE

Write the number on the Configuration Record Sheet in the configuration section so you will have a permanent record.

Table 4-1 Procedure to Enter a Security Code

Step	Operation	Press	Result
1	Enter Set Up Mode		Upper Display = SET UP Lower Display = LOCK
2	Select any Set Up Group		Upper Display = 0 Lower Display = SECUR
3	Security Code Entry	 or 	To enter a four digit number in the upper display (0001 to 9999) This will be your security code.

4.4 Lockout Feature

Introduction

The lockout feature in the UDC2500 is used to inhibit changes (via keyboard) of certain functions or parameters by unauthorized personnel.

Lockout levels

There are different levels of Lockout depending on the level of security required. These levels are:

- NONE No Lockout. All groups Read/Write.
- CAL All groups Read/Write except Calibration
- CONF Configuration parameters are Read only. No writes permitted. Calibration Group is not available.
- +SP Only the Lockout group is available for Read/Write. Setpoint value is Read Only.

See *Subsection 3.4- Lockout Parameters Set Up Group* prompts to select one of the above.

Key error

When a key is pressed and the prompt “Key Error” appears in the lower display, it will be for one of the following reasons:

- Parameter not available or locked out
- Not in setup mode, press **SET UP** key first

4.5 Monitoring Your Limit Controller

Annunciators

The following annunciator functions have been provided to help monitor the controller:

Table 4-2 Annunciators

Annunciator	Indication
ALM 1 2	<p><i>A visual indication of each alarm</i></p> <p>Blinking 1 indicates alarm latched and needs to be acknowledged before extinguishing when the alarm condition ends</p>
F or C	<p><i>A visual indication of the temperature units</i></p> <p>F—Degrees Fahrenheit</p> <p>C—Degrees Celsius</p>

Display Mode

The displays and indicators on the operator interface, as shown in Figure 4-1, let you see what is happening to your process and how the Limit Controller is responding.

The Limit Controller can be either a single line display device (except when in the SETUP mode or the **LOWER DISPLAY** key is pressed or limit has been reached) or it can be a dual line display device (upper display shows PV and lower display shows SP).

This display can be one of two types:

Single Display Mode 1

The PV is displayed in the upper display and the lower display is blank.

Single Display Mode 2

The setpoint is displayed in the upper display and “SP” is displayed in the lower display.

Viewing the operating parameters

Press the **LOWER DISPLAY** key to scroll through the operating parameters:

SP* Setpoint

PV Process Variable

* You can press ▲ or ▼ to change the value of this parameter.

Timing out from lower display

The normal variable display will automatically return in the upper display if the **LOWER DISPLAY** key is not pressed for 30 seconds.

Diagnostic Error Messages

The UDC2500 performs background tests to verify data and memory integrity. If there is a malfunction, an error message will be displayed. In the case of more than one simultaneous malfunction, the messages will be displayed sequentially on the lower display. If any of these error messages in Table 4-3 occur, refer to *Section 7 - Troubleshooting* for information to correct the failure.

Table 4-3 Error Messages

Prompt	Description
EE FAIL	Unable to write to nonvolatile memory.
IN1FL	Two consecutive failures of input 1 integration.
CNFERR	Configuration Errors—Low limit greater than high limit for PV or SP
IN1RNG	Input 1 Out-of-Range Out-of-range criteria: Linear range: ±10% out-of-range Characterized range: ±1% out-of-range
PV LIM	PV Out-of-Range PV = PV + PV bias
FAILSF	Failsafe — conditions for Failsafe are: ... EEROM Test Failed ... Scratch Pad RAM Test Failed ... Configuration Test Failed Check the “Status” group.
TCWARN	Thermocouple sensor is starting to burnout.
TCFAIL	Thermocouple sensor is in imminent danger of burning out.
OUT2 FL	Current Output 2 failure is less than 3.5 mA.

High and Low Limit Indication

When the high or low limit is exceeded, the lower display indicates the word “LIMIT” (blinking). The PV is indicated in the upper display. This will continue until the Out-of-Limit condition exists and you reset the latching relay using the **M-A RESET** key or through the Optional External Reset feature.

The Limit Relay *cannot* be reset while a Limit condition exists.

4.6 Operating Your Limit Controller

Operating Principles

The Limit Controller accepts signals from such sources as Thermocouples (T/Cs), Resistance Temperature Detectors (RTDs), and Radiamatics. The equivalent PV signal is compared with the Limit set point. If above (Hi Limit) or below (Lo Limit), a limit output relay is de-energized. When de-energized, the output relay locks out and remains in this state until the PV input signal drops below the high limit setpoint or rises above the low limit setpoint, and the controller is reset manually from the front of the controller or through an optional external switch.

Check the configuration

Make sure the Limit Controller has been configured to handle your process needs. Refer to *Section 3 - Configuration* for prompts and parameters.

- Input Parameters
- Alarm Set Points and type
- Limit Control Type - high or low
- External Reset (Contact Input) - enable or disable
- Power-up Logic - Reset (relay on) or Normal (same as before power down)
- Lockout selection



Power Up Logic

Configurable power-up logic lets you select the latching output relay to require “RESET” or to provide normal operation at power-up. If power to the limit controller fails and power is reapplied, the controller goes through power up tests then starts in one of the following configurable conditions:

- If you configured RST at setup group “LIMIT”, the lower display will blink “LIMIT” at power up. This will require reset via the **M-A RESET** key or external switch to obtain normal operation.
- If you configured NORM at setup group “LIMIT”, the display and limit controller will function normally at power up, (that is, no reset of the latching relay is required unless a limit has been exceeded). If the limit was latched when power went down, the unit will be in limit at power-up.

Refer to *Section 3 - Configuration, subsection 3.4 Limit Parameters Set Up Group* under SET UP prompt “LIMIT” and make your selection at FUNCTION prompt “POWRUP.”

How to set a limit setpoint

Step	Operation	Press	Result
1	Display setpoint		Press the "Lower Display" key till SP appears.
2	Enter the Limit Setpoint	▲ or ▼	Set the SP, using the Up & Down arrow keys, to the desired Limit Setpoint
3	Store the limit setpoint		Press the "Lower Display" to store the value.
4	If the display flashes "Limit"		Press the Auto-Man/ Reset key.

How to Reset the Latching Relay





The latching relay cannot be reset until the PV input signal drops below the high set point (High Limit) or rises above the low set point (Low Limit) value.

Press the **M-A RESET** key or make contact closure of an external switch if the External Reset option is present.

Using the Digital Input Option (External Reset)

The Contact Input option detects the state of external contacts. On contact closure, the controller will reset the latching relay if the controller has External Reset enabled. To allow External Reset (contact input) use the procedure in Table 4-4.

Table 4-4 Using Contact Input Option

Step	Operation	Press	Result
1	Select Options Set-up Group		Until you see: <i>Upper Display</i> = SET <i>Lower Display</i> = OPTIONS
2	Access the External Reset Prompt		Until you see: <i>Upper Display</i> = ENAB DIS <i>Lower Display</i> = DIGIN1
3	Change a value	 or 	To select ENAB in the upper display

4.7 Alarm Setpoints

Introduction

An alarm consists of a relay contact and an operator interface indication. The alarm relay is de-energized if setpoint 1 or setpoint 2 is exceeded.





The alarm relay is energized when the monitored value goes into the allowed region by more than the hysteresis.

The relay contacts can be wired for normally open (NO) energized or normally closed (NC) de-energized using internal jumper placement. See Table 2-3 in the *Section 2 – Installation* for alarm relay contact information.

There are four alarm setpoints, two for each alarm. The type and state (High or Low) is selected during configuration. See *Subsection 3– Configuration* for details.

Alarm Setpoints Display

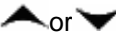
Table 4-5 Procedure for Displaying Alarm Setpoints

Step	Operation	Press	Result
1	Select Alarm Set-up Group		Until you see: <i>Upper Display = SET</i> <i>Lower Display = ALARMS</i>
2	Access the Alarm Setpoint Values		To successively display the alarm setpoints and their values. Their order of appearance is shown below. <i>Upper Display = (the alarm setpoint value)</i> <i>Range values are within the range of the selected parameters:</i> <i>DE (Deviation) value = within Input 1 Span</i> <i>PV (Process variable) value = Within Input 1 range</i>
3	Change a value		To change any alarm setpoint value in the upper display
4	Return to Normal Display		

4.8 P.I.E. Tool Maintenance Screens

Introduction

This controller uses special P.I.E. Tool[®] Maintenance Screens which allow remote access and access to functions not accessible via the controller’s display and keyboard. The figures in this section show screen-shots of the Maintenance Screens from the PC version of the P.I.E. Tool[®]. Pocket PC Maintenance Screens are generally similar in format but smaller.

ATTENTION

Your instrument may not have all of the screens and parameters shown in this section.

Loop Data

Select “Loop Data” from the “Maintenance Data” menu.

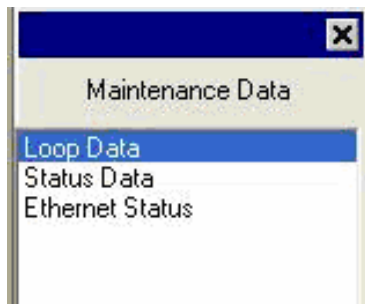

Figure 4-2 Maintenance Data Menu

The Loop Data screen allows you to see the current status of the process loop. “OP1, 2 and 3” windows indicate the status of the current outputs. If a current output is not installed, the OP status for that output is always “OK.”

The “Alarms” and “Digital Inputs” buttons allow you to see the current status of each alarm setpoint and digital input.

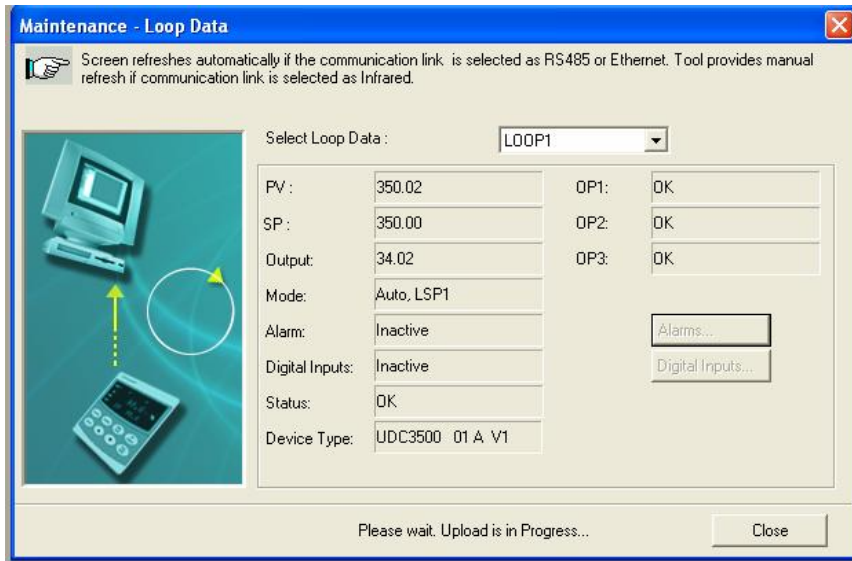

Figure 4-3 Loop Data Maintenance Screen

Loop Data – Digital Input Details

This screen appears when you click on the “Digital Inputs” button on the Loop Data Maintenance Screen and shows the status of each Digital Input. “NONE” in the Type column indicates that the Digital Input is disabled. Highlighted Digital Inputs are currently active. An asterisk (*) indicates that the alarm has changed state since the last communications transaction.

This instrument has a maximum of two Digital Inputs.

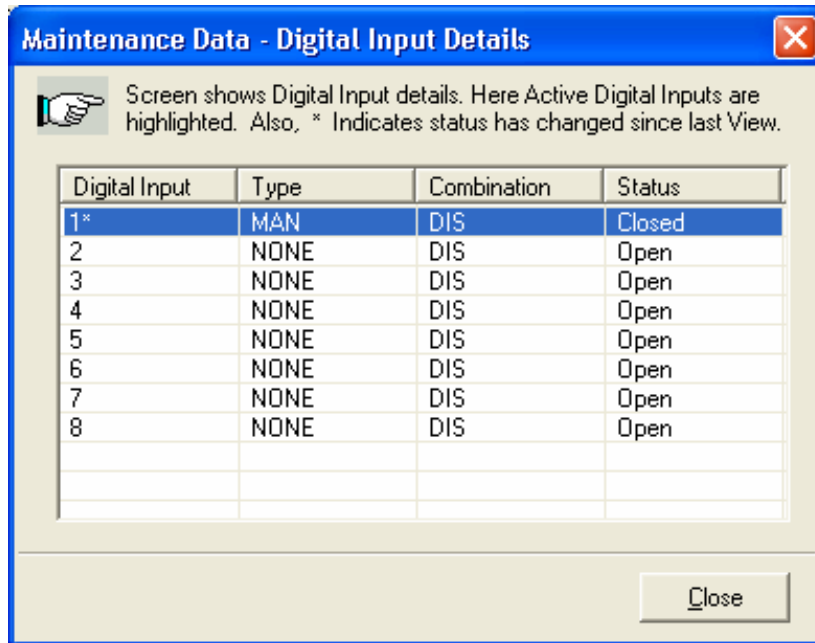
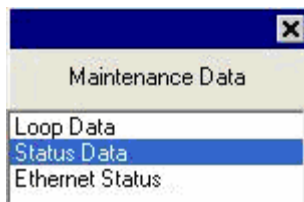

Figure 4-5 Digital Input Details Screen

Status Data

Select “Status Data” from the “Maintenance Data” menu.



The Status Data screen lets you see the current status of the controller’s diagnostics. If the controller has detected a problem, this screen will show the detected problem. If the controller is equipped with the Real Time Clock Option, then pressing the “Diagnostics” button will show the time and dates that the problem occurred and when it was cleared.

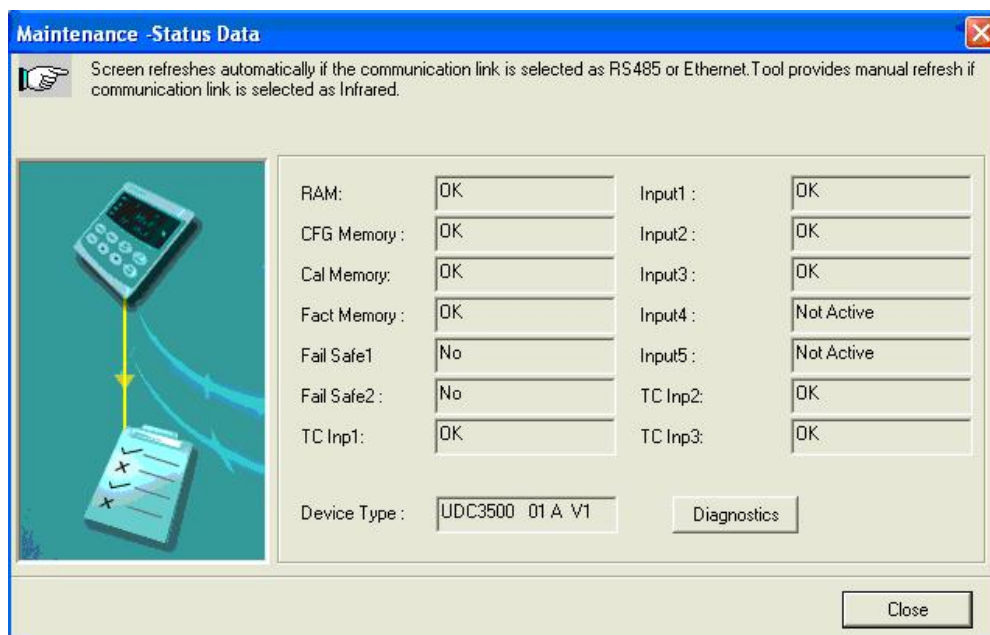
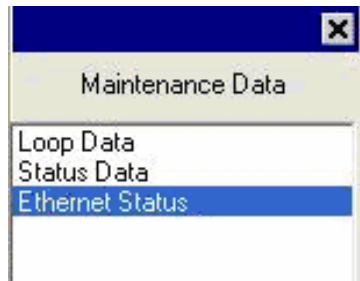

Figure 4-6 Status Data Maintenance Screen

Ethernet Status

Select “Ethernet Status” from the “Maintenance Data” menu.



This screen only appears in instruments that have the Ethernet Communications option. Essentially, this screen shows the same Ethernet diagnostic messages as available on the controller via the lower display window. See Section 7.5 for details.

The Ethernet Status screen shows the network status of the Ethernet Link. This may be accessed either via Ethernet or via Infrared communications. Not all diagnostic messages are available via Ethernet Communications. For example, if the Ethernet cable is unplugged, then the instrument cannot send up the “EUNPLGED” diagnostic message via Ethernet.

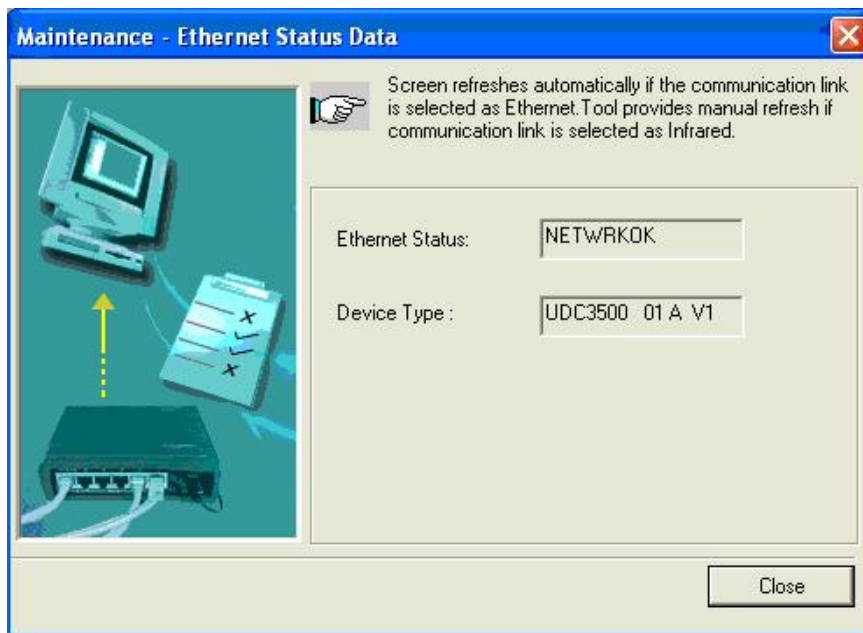

Figure 4-7 Ethernet Status Maintenance Screen

4.9 Configuring your Ethernet Connection

Introduction

This controller is shipped from the factory with the address for Infrared (IR) communications set to 3, the Ethernet IP Address set to 10.0.0.2, the Ethernet Subnet Mask set to 255.255.255.0 and the Ethernet Default Gateway set to 0.0.0.0. Consult your Information Technologies (IT) representative as to how these should be configured for your installation. The MAC address is printed on the product label located on the instrument's case.

Only the P.I.E. Tool[®] can be used to configure Ethernet parameters. The figures in this section show screen-shots from the PC version of the P.I.E. Tool[®] Screens. Pocket PC Screens are generally similar in format but smaller. The P.I.E. Tool can connect to your controller via either Ethernet communications port or the Infrared (IR) communications port.

Configuring the Controller via Infrared Communications

If connecting via IR and assuming that the instrument's IR address has not been changed from its factory setting of 3, then configure your Communications Type as "Infrared" and your IR address to 3 as shown below.

Select "PC COMM Setup", then, select "Infrared".

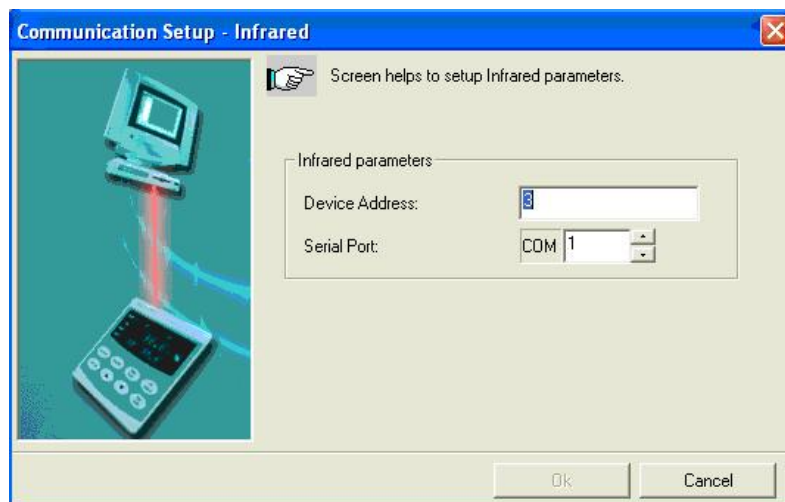
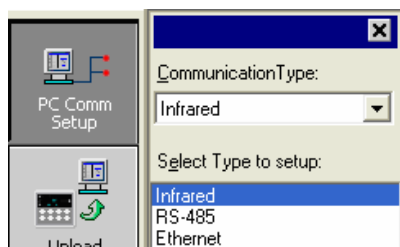
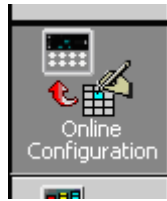

Figure 4-8 IR Communications Address

Close the IR configuration window and then single click on the “Online Configuration” button.



Press any button on the controller’s keyboard to activate the controller’s IR port. Point your IR dongle (if using PC) or your Pocket PC’s IR port (if using Pocket PC) at the IR window on the front of the controller and then click on the “Start” button. The P.I.E. Tool[®] should start uploading the configuration information from the controller as shown below:

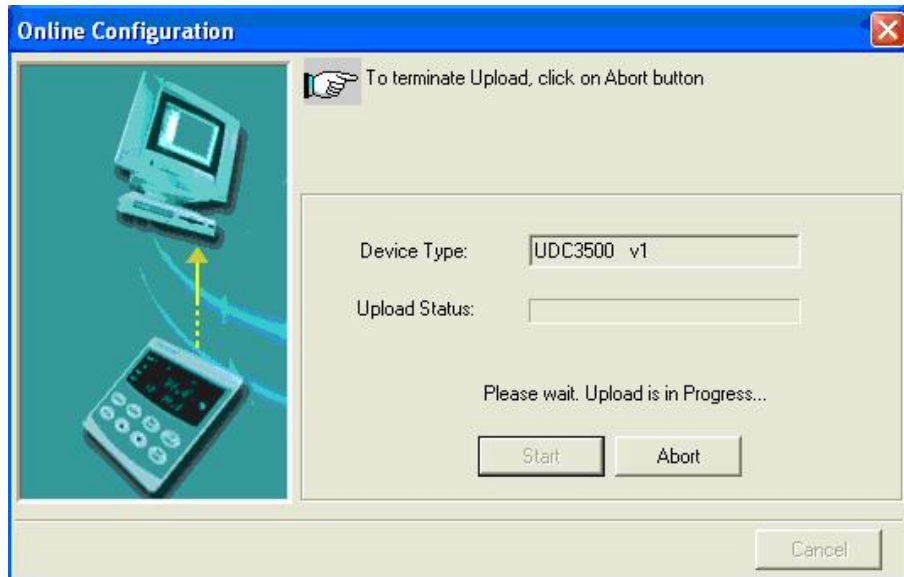

Figure 4-9 Configuration Upload in Progress

Once the upload is complete, click on the “Ethernet & Email” Group. Configure your Ethernet and Email parameters per Section 3.11.

Once you have changed the Ethernet settings and downloaded them to your controller, you will be able to communicate with it via Ethernet.

Configuring the Controller via Ethernet Communications

WARNING

Configuring the Controller via Ethernet Communications requires that you change your PC's IP settings. If you have never done this before, then it is **strongly** recommended that you consult with your Information Technologies (IT) representative before proceeding.

First, write down the current Local Area Network (LAN) configuration values for your PC for its IP Address, Subnet Mask and Default Gateway settings. Put these someplace where you can find them later.

Connecting to the Ethernet Port in the Controller requires that you have either an Ethernet crossover cable or a MDI-compliant Switch or Hub available with a straight-through cable. The crossover cable can be used to directly connect your PC to the Controller while the Switch or Hub can be used to connect your PC and Controller to the Hub or Switch via straight-through cables.

Once you have made an Ethernet connection between your PC and the controller, then, change the Local Area Network (LAN) settings on your PC to be as follows:

IP Address: 10.0.0.3
 Subnet Mask: 255.255.255.0
 Default Gateway: 10.0.0.1

Now open your P.I.E. Tool[®] program and select “PC Comm Setup” and select Ethernet as your “Communication Type” as shown in Figure 4-10.

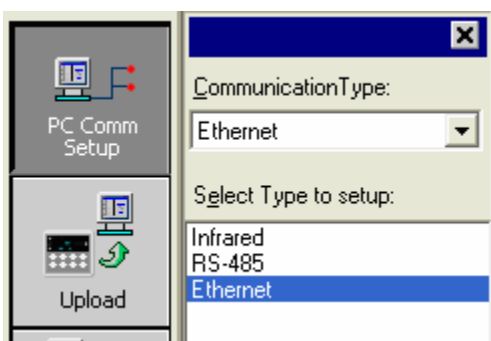

Figure 4-10 Ethernet Communications Type Selection

Now set your Ethernet address to 10.0.0.2 as shown in Figure 4-11.

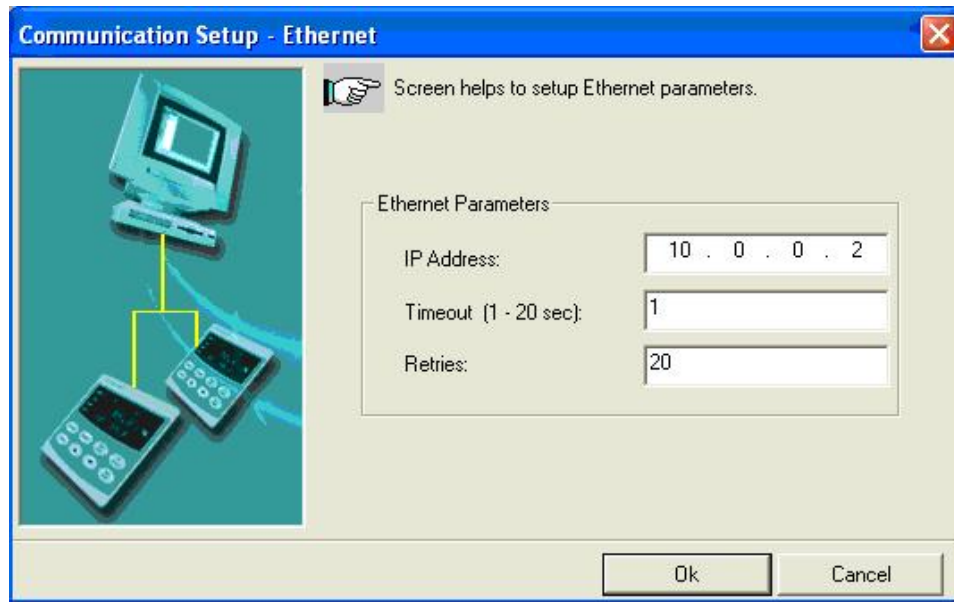
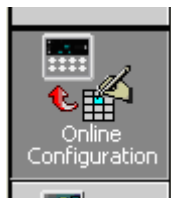

Figure 4-11 Ethernet Communications Address

Close the Ethernet configuration window and then single click on the “Online Configuration” button.



Then, click on the “Start” button. The P.I.E. Tool[®] should start uploading the configuration information from the controller as shown in Figure 4-12.

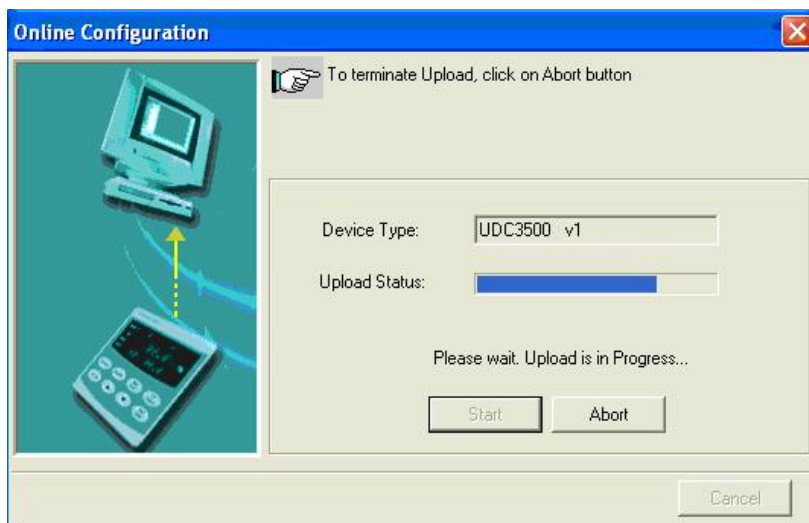

Figure 4-12 Configuration Upload in Progress

Once the upload is complete, click on the “Ethernet & Email” Group. Configure your Ethernet and Email parameters per Section 3.11.

Once you have changed the Ethernet settings and downloaded them to your controller, you will no longer be able to communicate with it until you change the IP address in the P.I.E. Tool[®] to be per the controller’s new IP Address.

You will also need to re-configure the Local Area Network (LAN) settings on your PC back to their original settings. On some PCs and LANs, it is possible to simply allow the PC to get these settings automatically via the DHCP server. Contact your Information Technologies (IT) representative to see if this is available on your PC.

5 Input Calibration



WARNING—SHOCK HAZARD

INPUT CALIBRATION MAY REQUIRE ACCESS TO HAZARDOUS LIVE CIRCUITS, AND SHOULD ONLY BE PERFORMED BY QUALIFIED SERVICE PERSONNEL. MORE THAN ONE SWITCH MAY BE REQUIRED TO DE-ENERGIZE UNIT BEFORE CALIBRATION.

5.1 Overview

Introduction

This section describes the field calibration procedures for Input 1.

- All input actuations in every UDC2500 controller are fully factory-calibrated and are ready for configuration by the user.
- Field Calibration can improve the accuracy of the Controller if necessary for a particular application.

CAUTION

The field calibration will be lost if a change in input type configuration is implemented at a later time. The original factory calibration data remains available for later use after a field calibration is done. See subsection 5.6 if you want to restore factory calibration values.

What's in this section?

The following topics are covered in this section.

TOPIC	See Page
5.1 Overview	69
5.2 Minimum and Maximum Range Values	70
5.3 Preliminary Information	72
5.4 Input #1 Set Up Wiring	73
5.5 Input #1 Calibration Procedure	78
5.6 Restore Input Factory Calibration	79

Calibration Steps

Use the following steps when calibrating an input.

Step	Action
1	Find the minimum and maximum range values for your PV input range from Table 5-1.
2	Disconnect the field wiring and find out what equipment you will need to calibrate.
3	Wire the calibrating device to your controller according to the set up wiring instructions for your particular input (Subsection 5.4).
4	Follow the calibration procedure given for Input #1 (Subsection 5.5).

5.2 Minimum and Maximum Range Values

Select the Range Values

Calibrate the controller for the minimum (0 %) and maximum (100 %) range values of your particular input type. Two input controllers will need to have each input calibrated separately.

Select the Voltage, Current or Resistance equivalents for 0 % and 100 % range values from Table 5-1. Use these values when calibrating your controller.

Table 5-1 Voltage, Milliamp and Resistance Equivalents for Input 1 Range Values

Sensor Type	PV Input Range		Range Values	
	°F	°C	0 %	100 %
Thermocouples (per ITS-90)				
B	0 to 3300	-18 to 1816	-0.100 mV	13.769 mV
E	-454 to 1832	-270 to 1000	-9.835 mV	76.373 mV
E (low)	-200 to 1100	-129 to 593	-6.472 mV	44.455 mV
J	0 to 1600	-18 to 871	-0.886 mV	50.060 mV
J (med)	20 to 900	-7 to 482	-0.334 mV	26.400 mV
J (low)	20 to 550	-7 to 288	-0.334 mV	15.650 mV
K	0 to 2400	-18 to 1316	-0.692 mV	52.952 mV
K (med)	-20 to 1200	-29 to 649	-1.114 mV	26.978 mV
K (low)	-20 to 750	-29 to 399	-1.114 mV	16.350 mV
NiMo-NiCo (NM90)	32 to 2500	0 to 1371	0.000 mV	71.773 mV
NM90 (low)	32 to 1260	0 to 682	0.000 mV	31.825 mV
Nicrosil-Nisil (Nic)	0 to 2372	-18 to 1300	-0.461 mV	47.513 mV
Nic (low)	0 to 1472	-18 to 800	-0.461 mV	28.455 mV
R	0 to 3100	-18 to 1704	-0.090 mV	20.281 mV

Sensor Type	PV Input Range		Range Values	
	°F	°C	0 %	100 %
S	0 to 3100	-18 to 1704	-0.092 mV	17.998 mV
T	-300 to 700	-184 to 371	-5.341 mV	19.097 mV
T (low)	-200 to 500	-129 to 260	-4.149 mV	12.574 mV
W5W26	0 to 4200	-18 to 2315	-0.234 mV	37.075 mV
W5W26 (low)	0 to 2240	-18 to 1227	-0.234 mV	22.283 mV
RP20-RP40	32 to 3216	0 to 1880	0.000 mV	4.933 mV
Thermocouple Differential *	-50 to 150	-46 to 66	-1.54 mV	4.62 mV
Radiamatic				
Type RH	0 to 3400	-18 to 1871	0.00 mV	57.12 mV
Type RI **	0 to 9999	0 to 9999	0.00 mV	60.08 mV
RTD Alpha = 0.00385 per IEC-60751 (1995)				
100 ohms	-300 to 1200	-184 to 649	25.202 ohms	329.289 ohms
100 ohms (low)	-300 to 300	-184 to 149	25.202 ohms	156.910 ohms
200 ohms	-300 to 1200	-184 to 649	50.404 ohms	658.578 ohms
500 ohms	-300 to 1200	-184 to 649	126.012 ohms	1646.445 ohms
Linear				
Milliamps	4 to 20 mA 0 to 20 mA		4.00 mA 0.00 mA	20.00 mA 20.00 mA
Millivolts	0 to 10 mV 0 to 50 mV 0 to 100 mV		0.00 mV 0.00 mV 0.00 mV	10.00 mV 50.00 mV 100.00 mV
Volts	1 to 5 Volts 0 to 5 Volts 0 to 10 Volts		1.00 Volts 0.00 Volts 0.00 Volts	5.00 Volts 5.00 Volts 10.00 Volts

* The Factory Calibrated millivolt values for the Thermocouple Differential Input are for a pair of J thermocouples at an ambient temperature mean of 450°F / 232°C. Other thermocouple types and ambient temperature means may be accomplished via Field Calibration of the input, with the range value limits being -4 mV to +16 mV for the zero and span values. See Table 5-7 for procedure.

** The range values for Radiamatic Type RI are customer configurable.

5.3 Preliminary Information

Disconnect the Field Wiring

Tag and disconnect any field wiring connected to the input terminals on the rear of the controller.

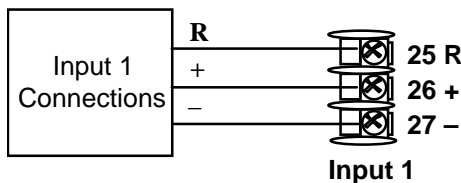

Figure 5-1 Input 1 Wiring Terminals

Equipment Needed

Table 5-2 lists the equipment you will need to calibrate the specific types of inputs that are listed in the table. You will need a screwdriver to connect these devices to your controller.

Table 5-2 Equipment Needed

Type of Input	Equipment Needed
Thermocouple Inputs (Ice Bath)	<ul style="list-style-type: none"> • A calibrating device with at least $\pm 0.02\%$ accuracy for use as a signal source such as a millivolt source. • Thermocouple extension wire that corresponds with the type of thermocouple that will be used with the controller input. • Two insulated copper leads for connecting the thermocouple extension wire from the ice baths to the mV source. • Two containers of crushed ice.
Thermocouple Inputs (T/C Source)	<ul style="list-style-type: none"> • A calibrating device with at least $\pm 0.02\%$ accuracy for use as a signal source such as a millivolt source. • Thermocouple extension wire that corresponds with the type of thermocouple that will be used with controller input.
RTD (Resistance Thermometer Device)	<ul style="list-style-type: none"> • A decade box, with at least $\pm 0.02\%$ accuracy, capable of providing stepped resistance values over a minimum range of 0 to 1400 ohms with a resolution of 0.1 ohm. • Three insulated copper leads of equal length for connecting the decade box to the controller.
Milliampere, Millivolt, Volts, and Radiamatic	<ul style="list-style-type: none"> • A calibrating device with at least $\pm 0.02\%$ accuracy for use as a signal source. • Two insulated copper leads for connecting the calibrator to the controller. • Place current source at zero before switching ON. • Do not switch current sources OFF/ON while connected to the UDC2500 input.

5.4 Input 1 Set Up Wiring

Thermocouple Inputs Using an Ice Bath

Refer to Figure 5-2 and wire the controller according to the procedure given in Table 5-3.

Table 5-3 Set Up Wiring Procedure for Thermocouple Inputs Using an Ice Bath

Step	Action
1	Connect the copper leads to the calibrator.
2	Connect a length of thermocouple extension wire to the end of each copper lead and insert the junction points into the ice bath.
3	Connect the thermocouple extension wires to the terminals for Input #1. See Figure 5-2.

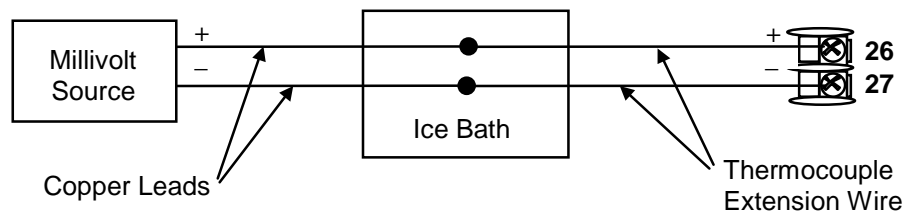

Figure 5-2 Wiring Connections for Thermocouple Inputs Using an Ice Bath

Thermocouple Inputs Using a Thermocouple Source

Refer to Figure 5-3 and wire the controller according to the procedure given in Table 5-4.

Table 5-4 Set Up Wiring Procedure for Thermocouple Inputs using Thermocouple Source

Step	Action
1	Connect the thermocouple extension wires to the terminals for Input #1 as shown in Figure 5-3.

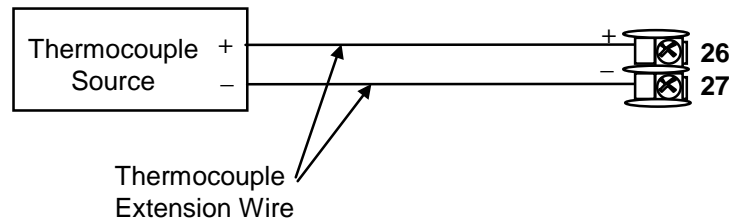

Figure 5-3 Wiring Connections for Thermocouple Inputs Using Thermocouple Source

RTD Inputs

Refer to Figure 5-4 and wire the controller according to the procedure given in Table 5-5.

Table 5-5 Set Up Wiring Procedure for RTD Inputs

Step	Action
1	Connect the copper leads from the calibrator to the Input #1 terminals as shown in Figure 5-4.

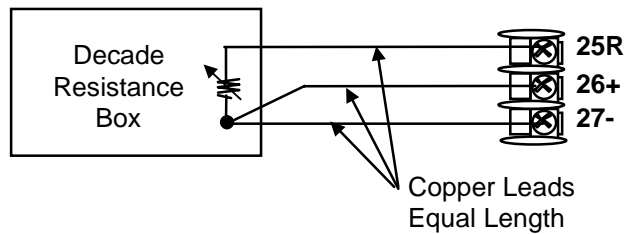

Figure 5-4 Wiring Connections for RTD (Resistance Thermometer Device)

Radiamatic, Millivolts, Volts or Thermocouple Differential Inputs

Refer to Figure 5-5 and wire the controller according to the procedure given in Table 5-6.

Table 5-6 Wiring Connections for Radiamatic, Thermocouple Differential, Millivolts or Volts (Except 0 to 10 Volts)

Step	Action
1	Connect the copper leads from the calibrator to the Input #1 terminals as shown in Figure 5-5.
2	Place current/voltage source at zero before switching on.
3	Do not switch current/voltage source ON/OFF while connected to the instrument.

ATTENTION

For Radiamatic inputs only, set Emissivity value to 1.0. See *Subsection 3.6 – Configuration Set Up* prompt INPUT1, function prompt EMISS.

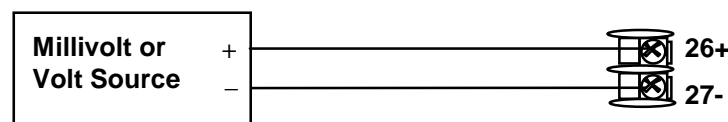

Figure 5-5 Wiring Connections for Radiamatic, Millivolts, Volts or Thermocouple Differential (Except 0 to 10 Volts)

Table 5-7 Procedure to determine calibration voltages for Thermocouple Differential input types other than the Factory Setting

Step	Action
1	Obtain a copy of the ITS-90 Standard for the Thermocouple Type you will be using.
2	Find the thermoelectric voltage for the desired operating temperature.
3	Find the thermoelectric voltages for the temperatures -50°F and $+150^{\circ}\text{F}$ away from the desired operating temperature.
4	The zero calibration voltage will be thermoelectric voltage for the -50°F temperature minus the thermoelectric voltage for the desired operating temperature. This will be a negative voltage.
5	The span calibration voltage will be thermoelectric voltage for the $+150^{\circ}\text{F}$ temperature minus the thermoelectric voltage for the desired operating temperature. This will be a positive voltage.

For example: Determine the calibration voltage values for a pair of J-type thermocouples at an operating temperature of 450°F (this is equivalent to the Factory setting).

- The ITS-90 standard for the J thermocouple shows that the thermoelectric voltage for 450°F is 12.568 millivolts.
- The -50°F point would be 400°F. The ITS-90 standard shows that the thermoelectric voltage for 400°F is 11.025 millivolts.
- The +150°F point would be 600°F. The ITS-90 standard shows that the thermoelectric voltage for 600°F is 17.188 millivolts.
- The zero calibration voltage is thus 11.025 minus 12.568 millivolts or -1.543 millivolts (this can be rounded off to -1.54 millivolts without significant loss of accuracy).
- The span calibration voltage is thus 17.188 minus 12.568 millivolts or +4.62 millivolts.
- Use -1.54 millivolts for the Zero calibration value and +4.62 millivolts for the Span calibration value.

0 to 10 Volts

Refer to Figure 5-6 and wire the controller according to the procedure given in Table 5-8.

Table 5-8 Set Up Wiring Procedure for 0 to 10 Volts

Step	Action
1	Connect the copper leads from the calibrator to the Input #1 terminals as shown in Figure 5-6.
2	Place voltage source at zero before switching on.
3	Do not switch voltage source ON/OFF while connected to the instrument.

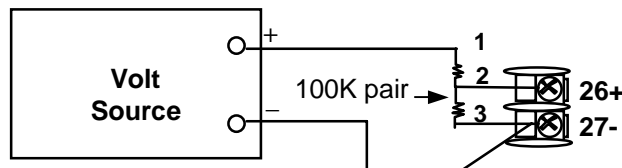

Figure 5-6 Wiring Connections for 0 to 10 Volts

Milliamperes

Refer to Figure 5-5 and wire the controller according to the procedure given in Table 5-6.

Table 5-9 Set Up Wiring Procedure for Milliampere Inputs

Step	Action
1	Connect the copper leads from the calibrator to the Input #1 terminals as shown in Figure 5-7.
2	Place current source at zero before switching on.
3	Do not switch current source ON/OFF while connected to the instrument.

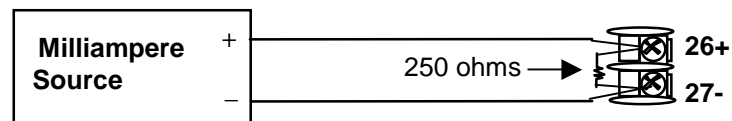

Figure 5-7 Wiring Connections for 0 to 20 mA or 4 to 20 mA Inputs

5.5 Input 1 Calibration Procedure

Preliminary Steps

- Apply power and allow the controller to warm up for 30 minutes before you calibrate.
- Please read *Subsection 5.4 – Input 1 Set Up Wiring* before beginning the procedure.
- **Make sure you have LOCK set to NONE. See Subsection 3.4.**
- See Table 5-1 for Voltage vs. Resistance equivalents or 0 % and 100 % range values.





CAUTION





For linear inputs, avoid step changes in inputs. Vary smoothly from initial value to final 100 % value.

Procedure

The calibration procedure for Input #1 is listed in Table 5-10. The numeric codes are also listed.

Table 5-10 Input 1 Calibration Procedure

Step	Operation	Press	Result
1	Enter Calibration Mode	 until you see 	<p><i>Upper Display = CAL</i> <i>Lower Display = INPUT1</i></p> <p>You will see: <i>Upper Display = DIS</i> <i>Lower Display = CALIN1</i></p> <p>The calibration sequence is enabled and you will see: <i>Upper Display = BEGN</i> <i>Lower Display = CALIN1</i></p> <p>At the completion of the sequence, the selection automatically reverts to disable.</p>
2	Calibrate 0 %		<p>You will see: <i>Upper Display = APLY</i> <i>Lower Display = IN1ZRO</i></p> <ul style="list-style-type: none"> • Adjust your calibration device to an output signal equal to the 0 % range value for your particular input sensor. See Table 5-1 for Voltage, Degrees, or Resistance equivalents for 0 % range values. • Wait 15 seconds, then go to the next step.
3	Calibrate 100 %		<p>You will see: <i>Upper Display = APLY</i></p>

Step	Operation	Press	Result						
			<p><i>Lower Display = IN1SPN</i></p> <ul style="list-style-type: none"> Adjust your calibration device to an output signal equal to the 100 % range value for your particular input sensor. See Table 5-1 for Voltage, Degrees, or Resistance equivalents for 100 % range values. Wait 15 seconds, and <table border="1"> <thead> <tr> <th>If ...</th> <th>Then ...</th> </tr> </thead> <tbody> <tr> <td>you are calibrating a Thermocouple input</td> <td>go to step 4</td> </tr> <tr> <td>you are calibrating other than a Thermocouple input</td> <td>go to step 5</td> </tr> </tbody> </table>	If ...	Then ...	you are calibrating a Thermocouple input	go to step 4	you are calibrating other than a Thermocouple input	go to step 5
If ...	Then ...								
you are calibrating a Thermocouple input	go to step 4								
you are calibrating other than a Thermocouple input	go to step 5								
4	Check the Cold Junction Temperature		<p>The calculations for zero and span are now stored and you will see:</p> <p><i>Upper Display =</i> The cold junction temperature at the rear terminals <i>Lower Display = CJTEMP</i></p> <p>The value in the upper display is in tenths of a degree. It is the current reading of the temperature as measured at the thermocouple terminals and recognized by the controller. You can change this value, if it is in error, using the  or  keys.</p> <p>WARNING: The accuracy of the controller is directly affected by the accuracy of this value. It is recommended that this value not be changed under normal circumstances.</p>						
5	Exit the Calibration Mode	 then 	<p>The controller stores the calibration constants and exits the calibration mode.</p>						

5.6 Restore Input Factory Calibration

Introduction

The factory calibration constants for all the input actuation types that can be used with the controller are stored in its non-volatile memory. Thus, you can quickly restore the “Factory Calibration” for a given input actuation type by simply changing the actuation type to another type and then changing it back to the original type.

Refer to Table 5-11 Restore Input Factory Calibration for procedure.







ATTENTION

A restored factory calibration overwrites any previous field calibration done for the input and may change the High and Low Range Limits.

Protect your field calibration from accidental overwrites by configuring the appropriate LOCKOUT selection after calibration.

See the *Section 3 - Configuration* for specific instructions to set the lockout.

Table 5-11 Restore Input Factory Calibration

Step	Operation	Press	Result
1	Set LOCKOUT to NONE		until you see: <i>Upper Display</i> = SET UP <i>Lower Display</i> = LOCK
			Until you see: <i>Upper Display</i> = one of the following: NONE – all parameters are read/write CAL – all parameters are read/write except Calibration CONF – configuration parameters are Read Only; no writes permitted <i>Lower Display</i> = LOCK
		▲ or ▼	Until NONE is in the upper display
2	Enter INPUT 1 Setup Group		until you see: <i>Upper Display</i> = SET UP <i>Lower Display</i> = INPUT 1
			until you see: <i>Upper Display</i> = the current selection <i>Lower Display</i> = IN1TYP
		▲ or ▼	to change the current selection to another selection
3	Scroll through Functions		until the lower display rolls through the rest of the functions and returns to: <i>Upper Display</i> = the new selection <i>Lower Display</i> = INxTYP
		▲ or ▼	until you change the input selection in the upper display back to the proper selection. You will see: <i>Upper Display</i> = Original Input Selection that matches your type of sensor. <i>Lower Display</i> = INxTYP
4	Return to Normal Operation		to return to Normal operating mode. The factory calibration will be restored.

6 Output Calibration

6.1 Overview

Introduction

This section describes the field calibration procedures for the Auxiliary Output.

What's in this section?

The following topics are covered in this section.

TOPIC	See Page
6.1 Overview	83
6.2 Auxiliary Output Calibration	83
6.3 Restore Output Factory Calibration	85



WARNING—SHOCK HAZARD

OUTPUT CALIBRATION MAY REQUIRE ACCESS TO HAZARDOUS LIVE CIRCUITS, AND SHOULD ONLY BE PERFORMED BY QUALIFIED SERVICE PERSONNEL. MORE THAN ONE SWITCH MAY BE REQUIRED TO DE-ENERGIZE UNIT BEFORE CALIBRATION.

6.2 Auxiliary Output Calibration

Introduction

Calibrate the controller so that the auxiliary output provides the proper amount of current over the desired range. The controller can provide an auxiliary current output range of from 0 mA to 20 mA and can be calibrated at 4 mA for 0 % of output and 20 mA for 100 % of output or any other values between 0 mA and 21 mA.

Equipment Needed

You will need a calibrating device with whatever accuracy is required, capable of measuring 0 to 20 mA.

Calibrator Connections

Refer to Figure 6-1 and wire the controller according to the procedure given in Table 6-1.

Table 6-1 Set Up Wiring Procedure for Auxiliary Output

Step	Action
1	Apply power and allow the controller to warm up 30 minutes before you calibrate.
2	Set LOCK in the Tuning Set Up group to NONE.
3	Tag and disconnect the field wiring, at the rear of the controller, from terminals 12 (+) and 13 (-). See Figure 6-1.
4	Connect a milliammeter across these terminals.

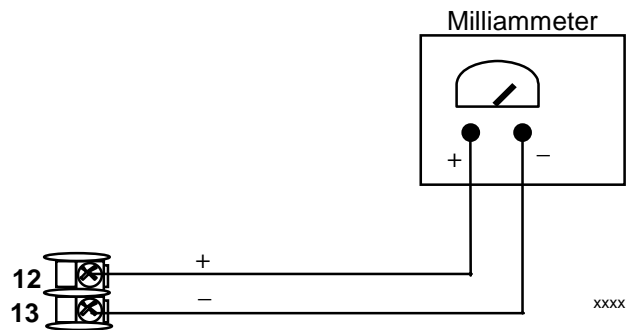











Figure 6-1 Wiring Connections for Calibrating Auxiliary Output

Procedure

The procedure for calibrating the auxiliary output is listed in Table 6-2. The numeric codes are also listed.

Make sure “LOCK” in the Lock Set Up group is set to “NONE” (see *Subsection 3.4*).

Table 6-2 Auxiliary Output Calibration Procedure

Step	Operation	Press	Result
1	Enter Calibration Mode		<i>Upper Display = CAL</i> <i>Lower Display = AUXOUT</i>
		until you see	
2	Calibrate 0 %		You will see: <i>Upper Display = A Value</i> <i>Lower Display = ZROVAL</i>
		 or 	until the desired 0 % output is read on the milliammeter, use the values shown below depending on the action of your controller.
3	Calibrate 100 %		To store the 0 % value you will see: <i>Upper Display = A Value</i> <i>Lower Display = SPNVAL</i>
		 or 	until the desired 100 % output is read on the milliammeter.
4	Exit the Calibration Mode		The controller stores the span value.
			To exit the calibration mode.

6.3 Restore Output Factory Calibration

Introduction









The factory calibration constants for the Auxiliary Outputs are stored in its non-volatile memory. Thus, you can quickly restore the “Factory Calibration” for those outputs by simply changing the ARANGE to the other setting and then changing it back to the original type.

Refer to Table 6-3 Restore Factory Calibration for procedure

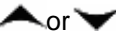
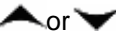
ATTENTION

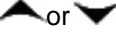
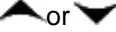
A restored factory calibration overwrites any previous field calibration done for the output. Protect your field calibration from accidental overwrites by configuring the appropriate LOCKOUT selection after calibration. See *Section 3 - Configuration* for specific instructions to set the lockout.

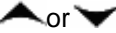
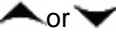
Table 6-3 Restore Factory Calibration

Step	Operation	Press	Result
1	Set LOCKOUT to NONE		until you see: <i>Upper Display</i> = SET <i>Lower Display</i> = TUNING
			Until you see: <i>Upper Display</i> = one of the following: NONE – all parameters are read/write CAL – all parameters are read/write except Calibration CONF – configuration parameters are Read Only; no writes permitted VIEW – Tuning and Setpoint Ramp parameters are read/write. No other parameters can be viewed. ALL – Tuning and Setpoint Ramp parameters are available for read only. No other parameters can be viewed. <i>Lower Display</i> = LOCK
2	Enter OUTPUT or OPTIONS Setup Group	 or 	Until NONE is in the upper display
			until you see: <i>Upper Display</i> = SET <i>Lower Display</i> = OPTION (for the Auxiliary Output)
3	Scroll through Functions		until you see: <i>Upper Display</i> = the current selection <i>Lower Display</i> = ARANGE (for the Auxiliary Output)
		 or 	to change the range configuration to the other selection
			until the lower display rolls through the rest of the functions and returns to: <i>Upper Display</i> = the new selection <i>Lower Display</i> = ARANGE (for the Auxiliary Output)
4	Return to Normal Operation	 or 	to change the range selection in the upper display back to the proper selection. You will see: <i>Upper Display</i> = Original range selection <i>Lower Display</i> = ARANGE (for the Auxiliary Output)
			to return to Normal operating mode. The factory calibration will be restored.

7 Troubleshooting/Service

7.1 Overview

Introduction

Instrument performance can be adversely affected by installation and application problems as well as by hardware problems. We recommend that you investigate the problems in the following order:

- installation related problems
- application related problems
- hardware and software related problems

and use the information presented in this section to solve them.

What's in this section?

The following topics are covered in this section.

TOPIC		See Page
7.1	Overview	87
7.2	Troubleshooting Aids <ul style="list-style-type: none"> • Overall Error Messages • Controller Failure Symptoms • Customer Support • Determining the Software Version Number 	88
7.3	Power-up Tests	90
7.4	Status Tests	90
7.5	Background Tests	91
7.6	Controller Failure Symptoms	93
7.7	Troubleshooting Procedures <ul style="list-style-type: none"> • Power Failure • Alarm Relay Output Failure • Keyboard Failure 	94
7.8	Restore Factory Configuration	100

Installation related problems

Read the Installation section in this manual to make sure the UDC2500 has been properly installed. The installation section provides information on protection against electrical

noise, connecting external equipment to the controller, and shielding and routing external wiring.

ATTENTION

System noise induced into the controller will result in diagnostic error messages recurring. If the diagnostic error messages can be cleared, it indicates a “soft” failure and is probably noise related.

If system noise is suspected, completely isolate the controller from all field wiring. Use calibration sources to simulate PV and check all controller functions; i.e. Gain, Rate, Reset, Output, Alarms, etc.

Application related problems

Review the application of the controller; then, if necessary, direct your questions to the local sales office.

Hardware and software related problems

Use the troubleshooting error message prompts and controller failure symptoms to identify typical failures which may occur in the controller. Follow the troubleshooting procedures to correct them.

7.2 Troubleshooting Aids

Overall error messages

An error message can occur:

- At power-up. See Subsection 7.3.
- When the Status Tests are requested. See Subsection 7.4.
- During continuous background tests while in normal operation. See Subsection 7.5.

Controller failure symptoms

Other failures may occur that deal with the Power, Output, or Alarms. Refer to the controller failure symptom in Table 7-4 to determine what is wrong and the troubleshooting procedures to use to correct the problem.



Check installation

If a set of symptoms still persists, refer to *Section 2 - Installation* and ensure proper installation and proper use of the controller in the system.

Determining the software version

Table 7-1 lists the procedure for identifying the software version number.

Table 7-1 Procedure for Identifying the Software Version

Step	Operation	Press	Result
1	Select STATUS Set Up Group		<i>Upper Display</i> = READ <i>Lower Display</i> = STATUS
2	Read the software version		You will see: <i>Upper Display</i> = Software version number 26xx <i>Lower Display</i> = VERSION

Please give this number to the Customer Support person. It will indicate which version of UDC2500 you have and help them determine a solution to your problem.

7.3 Power-up Tests

What happens at power-up

When power is applied, the controller will run three diagnostic tests. After these tests are completed, “TEST DONE” is displayed.

Test Failures

If one or more of these tests fail, the controller will go to the Failsafe Manual Mode, and FAILSF will flash in the lower display and a message indicating which test failed will appear in the lower display. Then, “DONE” will appear in the lower display.

7.4 Status Tests



Introduction

When required, the results of these tests can be checked to determine the reason the controller has gone to Failsafe.

How to check the status tests

The procedure in Table 7-2 tells you how to display the results of the status tests.

Table 7-2 Procedure for Displaying the Status Test Results

Step	Operation	Press	Result
1	Select STATUS Set Up Group		Upper Display = READ Lower Display = STATUS
2	Read the test results		You will see: Upper Display = NO or YES YES indicates a failure Lower Display = FAILSAFE
			Upper Display = PASS or FAIL Lower Display = TEST

7.5 Background Tests

Introduction

The UDC2500 performs ongoing background tests to verify data and memory integrity. If there is a malfunction, a diagnostic message will be displayed (blinking) in the lower display.

In the case of simultaneous malfunctions, the messages will appear in sequence in the lower display. Table 7-3 lists these background tests, the reason for their failure, and how to correct the problem.

Diagnostic messages may be suppressed (stop the blinking) by pressing the **RUN/HOLD** key. The messages will still be available for viewing by pressing the **LOWER DISPLAY** key.

Table 7-3 Background Tests

Lower Display	Reason for Failure	How to Correct the Problem
E FAIL	Unable to write to non-volatile memory. Anytime you change a parameter and it is not accepted, you will see E FAIL.	<ol style="list-style-type: none"> 1. Check the accuracy of the parameter and re-enter. 2. Try to change something in configuration. 3. Run through Read STATUS tests to re-write to EEPROM.
FAILSF	<p>This error message shows whenever the controller goes into a failsafe mode of operation. This will happen if:</p> <ul style="list-style-type: none"> • RAM test failed • Configuration test failed • Calibration test failed • Burnout configured for none and the input failed. 	<ol style="list-style-type: none"> 1. Run through STATUS check to determine the reason for the failure. 2. Press the SET UP key until STATUS appears in the lower display. 3. Press the FUNCTION key to see whether the tests pass or fail, then run through the STATUS codes a second time to see if the error cleared.
IN1RNG	Input 1 out of range. The process input is outside the range limits.	<ol style="list-style-type: none"> 1. Make sure the range and actuation are configured properly. 2. Check the input source. 3. Restore the factory calibration. (See <i>Subsection 5.6.</i>) 4. Field calibrate. See <i>Section 5 - Input Calibration.</i>
IN1_FL	<p>Two consecutive failures of input 1 integration; i.e., cannot make analog to digital conversion. This will happen if:</p> <ul style="list-style-type: none"> • Upscale or Downscale burnout is selected and the input is open • Input not configured correctly for the sensor being used 	<ol style="list-style-type: none"> 1. Make sure the actuation is configured correctly. See <i>Section 3 - Configuration.</i> 2. Make sure the input is correct and that it has not burned-out (opened). 3. Check for gross over-ranging with a multimeter. 4. Restore factory calibration. See <i>Subsection 5.6.</i>

Lower Display	Reason for Failure	How to Correct the Problem
PV LIM	PV out of range. $PV = INP1 \times RATIO1 + INP1 \text{ BIAS}$	1. Make sure the input signal is correct. 2. Make sure the Ratio and Bias settings are correct. 3. Recheck the calibration. Use Bias of 0.0
TCWARN	The Thermocouple is starting to burnout.	This is a warning message that the controller has detected that the thermocouple is starting to burnout. This error message may also be created if the resistance of the wires used to connect the thermocouple to the instrument are above 100 ohms.
TCFAIL	The Thermocouple is in imminent danger of burning out.	This is a warning message that the controller has detected that the thermocouple will soon fail. User should consider replacing the thermocouple as soon as possible.
OUT2FL	Auxiliary Output is less than 3.5 mA.	The auxiliary output is open circuit. Check the field wiring. See Procedure #9.

7.6 Controller Failure Symptoms

Introduction

In addition to the error message prompts, there are failure symptoms that can be identified by noting how the controller displays and indicators are reacting.

Symptoms

Compare your symptoms with those shown in Table 7-4.

Table 7-4 Controller Failure Symptoms

Upper Display	Lower Display	Indicators	Controller Output	Probable Cause	Troubleshooting Procedure
Blank	Blank	Off	None	Power Failure	1
OK	Displayed Output disagrees with controller output	OK	Controller Output disagrees with displayed output	Relay Output	2
OK	OK	OK	External Alarm function does not operate properly	Malfunction in alarm output	3
Display does not change when a key is pressed				Keyboard Malfunction	4
Controller fails to go into "Slave" operation during communications				Communications Failure	5
OK	Displayed Output disagrees with Auxiliary Output	OK	Controller Auxiliary Output disagrees with Displayed Auxiliary Output	Auxiliary Output	6

Other symptoms

If a set of symptoms or prompts other than the one you started with appears while troubleshooting, re-evaluate the symptoms. This may lead to a different troubleshooting procedure.

If the symptom still persists, refer to the installation section in this manual to ensure proper installation and proper use of the controller in your system.

7.7 Troubleshooting Procedures

Introduction

The troubleshooting procedures are listed in numerical order as they appear in Table 7-4. Each procedure lists what to do if you have that particular failure and how to do it or where to find the data needed to accomplish the task.



WARNING—SHOCK HAZARD

TROUBLESHOOTING MAY REQUIRE ACCESS TO HAZARDOUS LIVE CIRCUITS, AND SHOULD ONLY BE PERFORMED BY QUALIFIED SERVICE PERSONNEL. MORE THAN ONE SWITCH MAY BE REQUIRED TO DE-ENERGIZE UNIT BEFORE SERVICING.

Equipment needed

You will need the following equipment in order to troubleshoot the symptoms listed in the tables that follow:

- Multimeter – Capable of measuring millivolts, milliamps and resistance.
- Calibration sources – T/C, mV, Volt, etc.

Procedure #1

Table 7-5 explains how to troubleshoot power failure symptoms.

Table 7-5 Troubleshooting Power Failure Symptoms

Step	What to do	How to do it
1	Check the AC line voltage.	Use a voltmeter to measure the AC voltage across terminals L1 and L2 on the rear terminal panel of the controller. Check the earth ground connection.
2	Make sure the chassis plugs into the rear of the case properly.	Withdraw the chassis and visually inspect the controller board and the inside of the case.
3	Check the system for Brown-outs, heavy load switching, etc., and conformance to installation instructions.	Refer to <i>Section 2 - Installation</i> .
4	Change Power board.	Installation instructions supplied with new board.

Procedure #2

Table 7-6 explains how to troubleshoot Latching Output Relay failure.

Table 7-6 Troubleshooting Latching Output Relay Failure

Step	What to do	How to do it
1	Make sure all the configurable data stored in the controller is correct. Reconfigure, if necessary.	Refer to Section 3 - Configuration to check all this data and how to reconfigure.
2	Check that the Latching Relay actuates properly.	Move the setpoint above or below the PV value, depending on the type of Limit Control configured. Listen for the click of the relay as the setpoint is moved above or below the PV.
3	Check the Latching Relay jumper position (NO or NC).	Refer to Section 2.4 Limit Control and Alarm Relay Contact Information for Relay Contact information.

Procedure #3

Table 7-7 explains how to troubleshoot Alarm Relay Output failure.

Table 7-7 Troubleshooting Alarm Relay Output Failure

Step	What to do	How to do it
1	Check the alarm configuration data. If it is correct, check the field wiring.	Reconfigure if necessary. Refer to <i>Section 3 - Configuration</i> for details.
2	Check that the applicable alarm relay actuates properly depending on what you have set at prompt AxSxTY. If it does, check the field wiring.	If the alarm type is set for PV, place the controller in manual mode. Vary the input to raise and lower the PV around the setpoint. Listen for a click from the relay as the PV moves in either direction and note that the proper ALM1 or ALM2 is lit.
3	Check the contacts.	Make sure the NO or NC contact wiring is correct. Refer to <i>Section 2 - Installation</i> for relay contact information.
4	Change the relay and/or the current output board.	Installation instructions supplied with the new relay or board.
5	Change MCU board.	Installation instructions supplied with the new board.

Procedure #4

Table 7-8 explains how to troubleshoot a Keyboard failure.



Table 7-8 Troubleshooting a Keyboard Failure

Step	What to do	How to do it
1	Make sure the keyboard is connected properly to the MCU/output and power/input boards.	Withdraw the chassis from the case and visually inspect the connection.
2	Controller Keyboard or specific keys may be LOCKED OUT via the security code.	Use your four-digit security code number to change the lockout level. Refer to <i>Section 3 – Configuration</i> .
3	Run the keyboard test.	<p>Press the SET UP key and hold in, then press the FUNCTION key at the same time. The controller will run a display test. Then you will see:</p> <p style="text-align: center;">Upper Display <div style="border: 1px solid black; padding: 2px; width: fit-content; margin: 0 auto;">KEYS</div></p> <p style="text-align: center;">Lower Display <div style="border: 1px solid black; padding: 2px; width: fit-content; margin: 0 auto;">TRY ALL</div></p> <p>Press each key. If it works, the key name will appear in the lower display.</p>
4	Replace the display/keyboard if any keys are shorted out.	Refer to <i>“Parts Replacement Procedures”</i> in this section.

Procedure #5

Table 7-8 explains how to troubleshoot a Communications failure.

Table 7-9 Troubleshooting a RS-485 Communications Failure

Step	What to do	How to do it
1	Check the field wiring and termination resistor.	Using an ohm meter, check the resistance across the communications rear terminals. See Section 2.7 for wiring diagrams.
2	Make sure the Communications Printed Wiring Board is installed properly in the controller.	Withdraw the chassis from the case and inspect the board. See the exploded view (Figure 8-1) for location of the board. Return the chassis to the case.
3	<p>Determine if the Communications board is faulty by running a LOCAL LOOPBACK TEST.</p> <p>If the test fails, replace the board. If the test passes, the problem is most likely elsewhere in the communications network.</p>	<p>Disconnect the communications cable from the rear terminals. Run the Local Loopback Test.</p> <p>Press SET UP key until you see:</p> <p>Upper Display <div style="border: 1px solid black; padding: 2px; display: inline-block;">SET UP</div></p> <p>Lower Display <div style="border: 1px solid black; padding: 2px; display: inline-block;">COM</div></p> <p>Press FUNCTION key until you see:</p> <p>Upper Display <div style="border: 1px solid black; padding: 2px; display: inline-block;">DISABLE</div></p> <p>Lower Display <div style="border: 1px solid black; padding: 2px; display: inline-block;">LOOPBACK</div></p> <p>Press  or  you will see:</p> <p>Upper Display <div style="border: 1px solid black; padding: 2px; display: inline-block;">ENABLE</div></p> <p>Lower Display <div style="border: 1px solid black; padding: 2px; display: inline-block;">LOOPBACK</div></p> <p>The test will run until the operator disables it here.</p>

Procedure #6

Table 7-10 explains how to troubleshoot AuxiliaryProportional Output failure symptoms.

Table 7-10 Troubleshooting Auxiliary Output Failure

Step	What to do	How to do it
1	Make sure the controller is configured for Auxiliary Output and the proper range (4 to 20 or 0 to 20) is configured.	<p>Make Options Set Up group function prompt AUX OUT any selection other than NONE. If this prompt does not show up, check if DIG IN 2 is enabled. If so, then as Auxiliary Ouptut and Digital Input 2 are mutually exclusive, you must chose which one of these features you wish to use.</p> <p>Make the Options Set UP group function prompt CRANGE = 4-20 or 0-20 per your application.</p> <p>Refer to <i>Section 3 - Configuration</i>.</p>
2	Check the field wiring.	Output impedance must be less than or equal to 1000 ohms.
3	Check the output.	Change the AUX OUT selection to OUTPUT. Put the controller into Manual mode and change the output from 0 % to 100 % (4-20 mA). Use a DC milliammeter at the rear terminals to verify the output.
4	Recalibrate the Auxiliary output.	Refer to <i>Section 6 - Output Calibration</i> for details.
5	Change Auxiliary Output board.	Installation instructions provided with new board.
6	Change Controller	

7.8 Restoring Factory Configuration

Introduction

This procedure restores the configuration of the instrument back to the Factory Settings per Section 3.12.

ATTENTION: Restoring the factory configuration overwrites all user-entered configuration changes. This procedure cannot be undone, it is a one-way process.

Table 7-11 explains how to restore Factory Configuration.

Table 7-11 Restoring Factory Configuration

Step	What to do
1	Turn off the power to the instrument for at least five seconds.
2	Turn the power back on and simultaneously press the “FUNCTION” and ▲ buttons. This must be done while “TEST DONE” is being displayed.
3	If step 2 was performed correctly, the instrument will now display “UDC” [Upper] “UPDATE” [Lower].
4	Press the Function Key. The instrument will now display “CFG” “RESTORE”
5	Press the Function Key. The instrument will now display “DOIN” “RESTORE”
6	When the instrument finishes the restore operation, it automatically resets itself and restarts in the product mode. The instrument configuration will now be the same as it was when the instrument left the factory and all user-entered configurations since that time have been overwritten.

8 Parts List

8.1 Exploded View

Introduction

Figure 8-1 is an exploded view of the UDC2500 Controller. Each part is labeled with a key number. The part numbers are listed by key number in Table 8-1. Parts not shown are listed in Table 8-2.

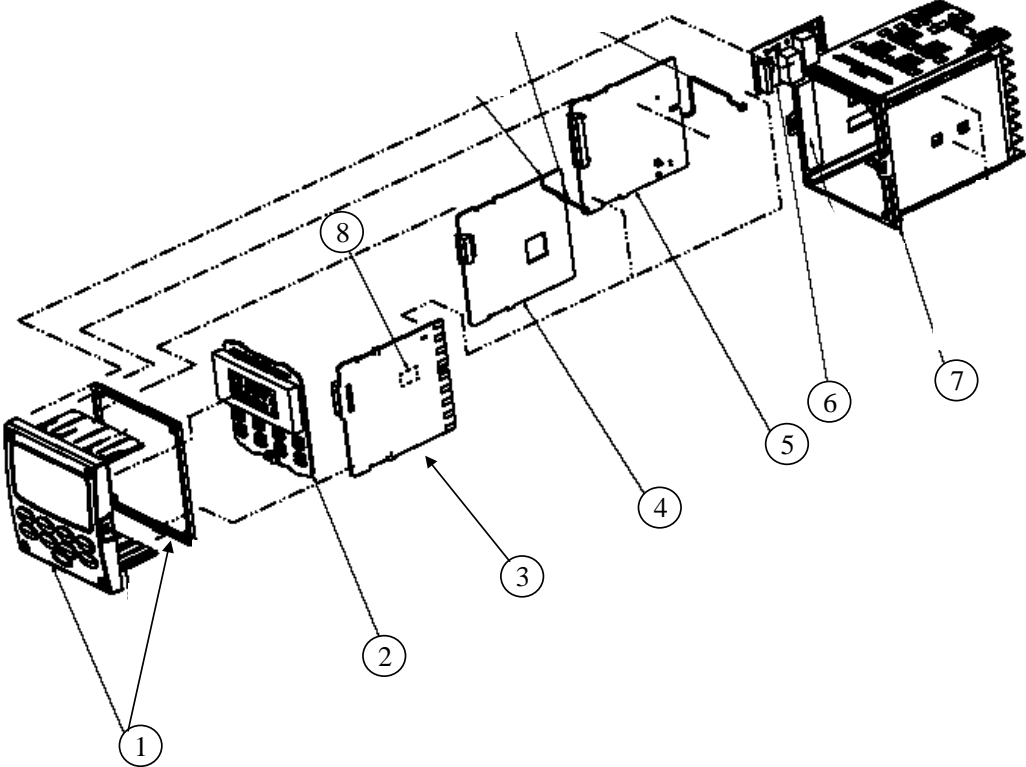

Figure 8-1 UDC2500 Exploded View

Table 8-1 Parts Identification

Key Number	Part Number	Description
1	51453143-501	Bezel Assembly and Bezel Gasket
2	51452758-502	Display/Keyboard (with IR)
3	51452822-502	Power/Output PWA (90-264 Vac Operation)
	51452822-503	Power/Output PWA (24 Vac/dc Operation)
4	51452810-501	Auxiliary Output/Digital Input/RS-422/485 Communications PWA
	51452816-501	Auxiliary Output/Digital Input/Ethernet Communications PWA
5	51452801-504	MCU/Inputs PWA (with IR) for Limit Controllers
6	30755306-501 30756679-501 30756725-501	Output 1 <ul style="list-style-type: none"> • Electro-Mechanical Relay • Open Collector Output PWA • Solid State Relay
7	51452759-501	Case Assembly (including Mounting Kit with four brackets)
8	30755306-501 30756679-501 30756725-501	Alarm 2 <ul style="list-style-type: none"> • Electro-Mechanical Relay • Open Collector Output PWA • Solid State Relay

Table 8-2 Parts Not Shown

Part Number	Description
30731996-506	4-20 mA Input Resistor Assembly (250 ohm)
30754465-501	0-10 Volt Input Resistor Assembly (100K pair)
51452763-501	Mounting Kits (12 brackets)

8.2 Removing the chassis

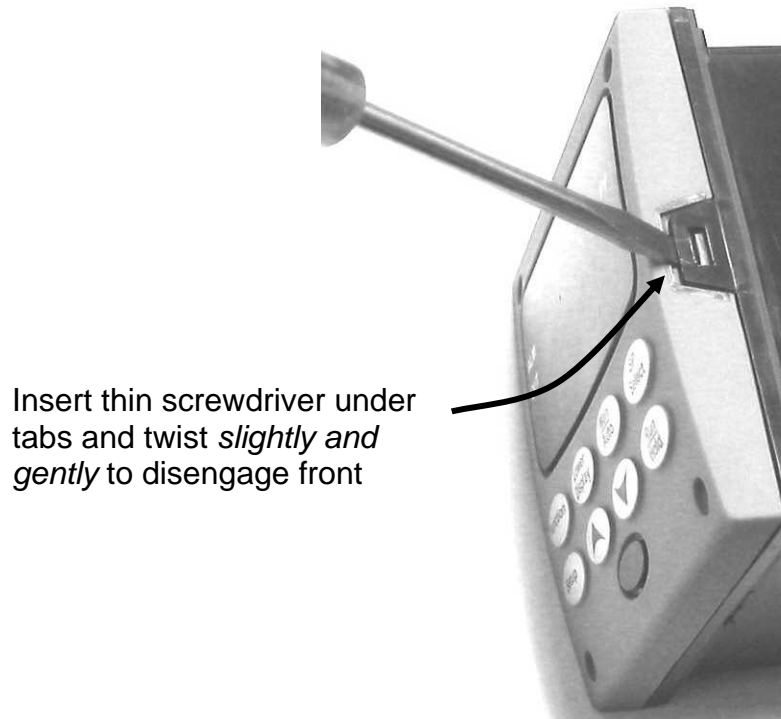

Using a thin screwdriver, *gently* twist the screwdriver to pry the side tabs from the front face. Pry just enough to release it, *otherwise you'll bend or break the tab*. If you break or bend the tab and can't reattach the front snugly, you'll need to reattach the front using the 4 NEMA4 screws provided. See Figure 2-3 on page 15.

9 Modbus RTU Function Codes

9.1 Overview

This section describes the function codes needed to upload and download the configuration from a host computer into this instrument.

What's in this section?

The following topics are covered in this section.

TOPIC	See Page
9.1 Overview	104
9.2 General Information	104
9.3 Function Code 20	106
9.4 Function Code 21	110

9.2 General Information

This instrument uses a subset of the standard Modbus RTU function codes to provide access to process-related information. Several MODICON function codes are implemented. It is appropriate to define instrument-specific "user-defined" function codes. Where differences occur between the two protocols it will be noted. Several standard Modbus RTU function codes are supported.

Configuration ID Tags

Function codes **20** and **21** use the RS422/485 tag IDs for accessing configuration and process-related data. These tags are fully explained in *Section 10*.

The tag IDs represent the register addresses used in the Request Message.

Other Modbus Codes

For Modbus codes **other than** for accessing configuration and process-related data for this controller, refer to the Modbus RTU Serial Communications User Manual # 51-55-25-66.

Register Address Structure

Table 9-1 Integer Parameter Type

Register Numbers (Dec)	Name	Access	Notes
1	Type = 1	NOT SUPPORTED	16-bit Unsigned Integer
2	Attribute	NOT SUPPORTED	1 = Read Only, 2 = Read/Write
3	Value (16 bit integer)	Read / Write	
4	Not Used	NOT SUPPORTED	
5	Low Range (16 bit integer)	NOT SUPPORTED	
6	Not Used	NOT SUPPORTED	
7	High Range (16 bit Integer)	NOT SUPPORTED	
8	Not Used	NOT SUPPORTED	
9 to 13	Description Text (ASCII string)	NOT SUPPORTED	

Table 9-2 Floating Point Parameter Type

Register Numbers (Dec)	Name	Access	Notes
1	Type = 2	NOT SUPPORTED	IEEE Floating Point
2	Attribute	NOT SUPPORTED	1 = Read Only, 2 = Read/Write
3	Value (float high word)	Read / Write	
4	Value (float low word)	NOT SUPPORTED	
5	Low Range (float high word)	NOT SUPPORTED	
6	Low Range (float low word)	NOT SUPPORTED	
7	High Range (float high word)	NOT SUPPORTED	
8	High Range (float low word)	NOT SUPPORTED	
9 to 13	Description Text (ASCII string)	NOT SUPPORTED	

Register Count

The register count depends on the data format of the registers being read or written.

Integer data is represented in sixteen bits and is transferred high byte first.

Floating point data is transferred in IEEE 32-bit format.

The register count definitions are:

0001 = Integer Data

0002 = Floating Point Data

9.3 Function Code 20 (14h) - Read Configuration Reference Data

Description

Function code 20 (14 Hex) is used in this instrument to read information stored in its configuration database. Each configuration item is explicitly addressed by a file number and register address. IEEE 32-bit floating point and 16-bit integer formats are supported.

Request and Response Formats

The Request and Response formats for Function code 20 (14 Hex) are shown below. Details for each block reference follow.

Request Message Format

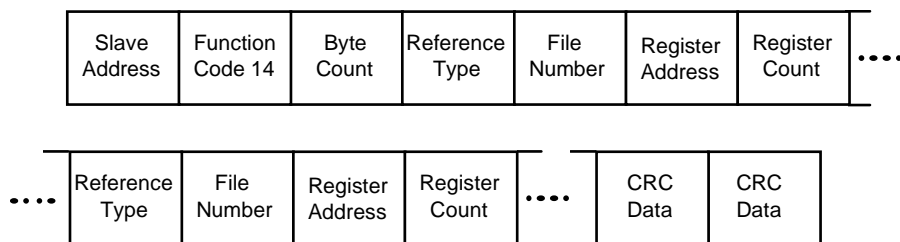

Response Message Format

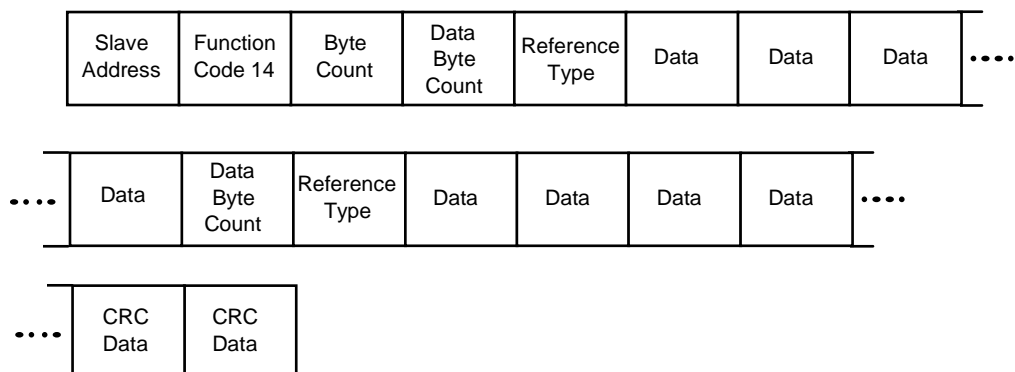

For Infrared Transactions, add three BOFs (C0hex) at the beginning of each message and one EOF (FFhex) at the end of each message.

Byte Count

The Byte Count equals the number of bytes transmitted in either the request or response message and will be the minimum number required to transmit all requested data.

Data Byte Count

The Data Byte Count is the number of data bytes of the *sub response* including the Reference Type but not including itself. A floating point sub response has four bytes of data and one byte representing the reference type making the data byte count equal to five.

Reference Type Definitions

The Reference Type definition is always 06.
See examples in Subsection 9.3.1

File Number

The file number word contains the register number from the register address structure tables on page 3. Although the register address structure tables indicate up to 13 data registers are available for access, only register address 3 is currently supported.

Register Address

The register address word represents the tag ID number for the parameter(s) being accessed. The register address word is made up of two bytes—the MSB = 00 always. The LSB contains the tag ID number. The tag ID numbers represent the parameter's register address(es). See *Section 3* for the tag ID numbers.

Table 9-3 Register Address Format for Function Code 20

Register Address(es) (Decimal)	Register Address(es) (Hex)	Format
001 to 125	0001 to 007D	analog formatted data (2 registers – IEEE 32-bit floating point)
128 to 255	0080 to 00FF	integer formatted data (1 register – 16-bit integer)

9.3.1 Read Configuration Examples

Example #1

The following is an example of a request to read the Gain 1 value using Function code 20.

Request Message (Read (Gain 1) = ID Tag 001) 02 14 07 06 00 03 00 01 00 02 (CRC16)
--

Where:

02	=	Address
14	=	Function Code 20 (14 hex)
07	=	Byte Count
06	=	Reference Type
00,03	=	File Number (Access Data Value)
00,01	=	Register Address (Standard Access Gain 1 - Tag ID #1)
00 02	=	Register Count (Floating Point Data)
(CRC16)		

This is the response to the above request.

Response Message 02 14 06 05 06 3F C0 00 00 (CRC16)

Where:

02	=	Address
14	=	Function Code 20 (14 Hex)
06	=	Byte Count
05	=	Sub Message Length
06	=	Reference Type (IEEE Floating Point)
3F C0 00 00	=	1.50 (Value of Proportional Band)
(CRC16)		

Example #2

The following is another example of a request and response message using Function code 20.

Request Message (Read LSP #1 = ID Tag 39 and LSP #2 = ID Tag 53)

```
02 14 0E 06 00 03 00 27 00 02 06 00 03 00 35 00 02 (CRC16)
```

Where:

```
02      = Address
14      = Function Code 20 (14 Hex)
0E      = Byte Count
06      = Reference Type (IEEE Floating Point)
00,03   = File Number (Access Data Value)
00,27   = Register Address (Standard Access LSP #1 - ID Tag 39)
00,02   = Register Count to read (Floating Point Data)
06      = Reference Type (IEEE Floating Point)
00,03   = File Number (Access Data Value)
00,35   = Register Address (Standard Access LSP #2 - ID Tag 53)
00,02   = Register Count to read (Floating Point Data)
(CRC16)
```

This is the response to the above request.

Response Message

```
02 14 0C 05 06 43 C8 00 00 05 06 44 60 00 00 (CRC16)
```

Where:

```
02      = Address
14      = Function Code 20 (14 Hex)
0C      = Byte Count
05      = Data Byte Count (Sub Message Length)
06      = Reference Type (IEEE Floating Point)
43 C8 00 00 = 400.0 (Value of Local Setpoint #1)
05      = Data Byte Count (Sub Message Length)
06      = Reference Type (IEEE Floating Point)
44 60 00 00 = 896.0 (Value of Local Setpoint #2)
(CRC16)
```

9.4 Function Code 21 (15h) - Write Configuration Reference Data

Introduction

Function Code 21 (15 Hex) is used in this instrument to allow writes of integer and floating point values to the configuration database and override values.

The configuration database of this instrument is located in EEROM. The override values are stored in RAM.

Integer format is used to write to “Digital” configuration items. Floating Point format is used to write to “Analog” configuration items as defined by the configuration ID tags.

Write Restrictions

Care should be taken not to exceed the 100,000 write limit of the EEROM.

Request and Response Formats

The Request and Response formats for Function code 21 (15 Hex) are shown below. Details for each block reference follow.

Request Message Format

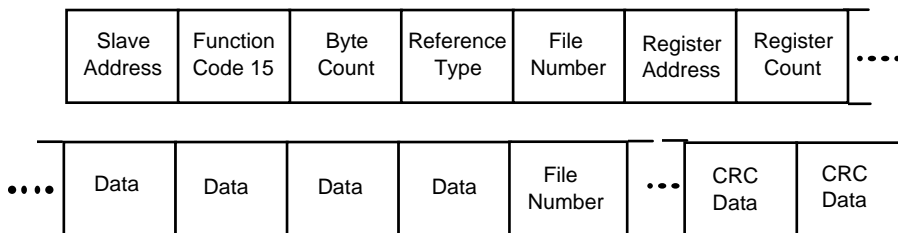

Response Message Format (echo back of request)

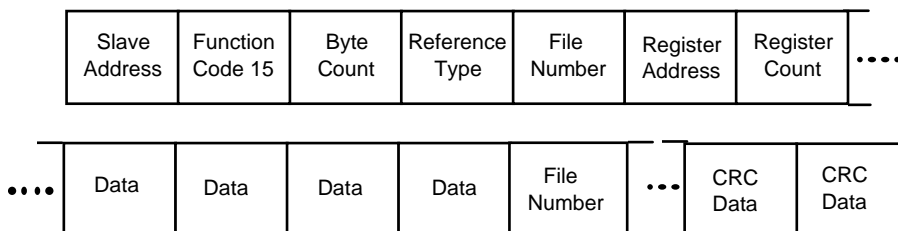

The register address is interpreted as the tag ID configuration number.

For Infrared Transactions, add three BOFs (C0hex) at the beginning of each message and one EOF (FFhex) at the end of each message.

Reference Type Definitions

The Reference Type definition is always 06.
See examples in Subsection 9.4.1

File Number

The file number word contains the register number from the register address structure shown in Table 9-1 and Table 9-2. Although the register address structure tables indicate up to 13 data registers are available for access, only register address 3 is currently supported.

Register Address

The register address is used to designate the tag ID number for the parameter being accessed. The register address is made up of two bytes—the MSB = 00 always. The LSB contains the RS422 tag ID number. The tag ID numbers represent the parameter's register address(es). See *Section 10* for the tag ID numbers.

Table 9-4 Register Address Format for Function Code 21

Register Address(es) (Dec)	Register Address(es) (Hex)	Format
001 to 125	0001 to 007D	analog formatted data (2 registers – IEEE 32-bit floating point)
128 to 215 & 255	0080 to 00D7 & 00FF	integer formatted data (2 registers – IEEE 32-bit floating point)

Unrestricted Registers

As mentioned previously, all register data is stored in the EEROM of this instrument with some exceptions. These exceptions were made to allow write access to override information. The registers, which are designated as Override values, are listed below. These registers do not have restrictions on the number of writes.

<i>ID Tag</i>	<i>Register Number</i>	<i>UDC Usage</i>
125	(7Dh)	Computer Setpoint

Restrictions on Parameter Numbers in One Message

The maximum number of writeable parameters per write request is 1.

9.4.1 Write Configuration Examples

Example #1

The following is an example of a request to write the Gain 1 value using Function code 21 (15 Hex).

Request Message (Write Gain 1= 1.5 “ID Tag 1”)

02 15 0B 06 00 03 00 01 00 02 3F C0 00 00 (CRC16)

Where:

02 = Address
15 = Function Code 21 (15 Hex)
0B = Byte Count
06 = Reference Type (IEEE Floating Point)
00 03 = File Number (Access Data Value)
00 01 = Register Address (Standard Access - Gain 1 - ID Tag 1)
00 02 = Register Count (Floating Point Data)
3F C0 00 00 = 1.50
(CRC16)

This is the response to the above request.

Response Message (The response is an echo of the request)

02 15 0B 06 00 01 00 02 00 02 3F C0 00 00 (CRC16)

10 Modbus Read, Write and Override Parameters plus Exception Codes

10.1 Overview

Introduction

This section contains information concerning Reading, Writing, and Overriding parameters in this instrument. There are two types of parameters:

- **Data Transfer**—These parameters include reading control data, option status, and reading or changing setpoints.
- **Configuration Data**—All the configuration data is listed in the order in which it appears in the controller.

Each type of parameter has the identifying codes listed with it.

What's in this section?

The following topics are covered in this section.

TOPIC	See Page
10.1 Overview	113
10.2 Reading Control Data	115
10.3 Miscellaneous Read Onlys	115
10.4 Configuration Parameters	116
10.5 Modbus RTU Exception Codes	125

General Information

Non-volatile Memory Retention

- This controller uses non-volatile memory to store configuration data. These memories are guaranteed to retain data for a minimum of ten years as long as the data is not written and erased more than 10,000 times. In order not to exceed this number, it is strongly recommended that configurations which change rapidly such as Computer Setpoint use the Override feature which does not affect non-volatile memory.

Analog Parameters

- Whenever analog register addresses 0001 through 0074 (those that can be changed via communications) are changed, a Write cycle occurs after receipt of the message and the response is returned.

Override Parameters

- Override analog register address 007D (computer setpoint) is not stored in non-volatile memory. It can be changed as frequently as desired with no effect on non-volatile memory retentivity, but the controller must remain in the slave mode.

Digital Parameters

- Whenever digital configuration register addresses 0080 through 00FA are updated via communications, the non-volatile memory is updated as soon as the message is received.

Communications Transfer Rates

- Reads minimum 20mS and writes minimum 200mS

Supported Function Codes

- IR port 20 and 21
- RS485 and Ethernet ports 1,2,3,4,6,16,17,20,21

Communications Modes of Operation

- When the Shed Timer is enabled and a write or override occurs the controller will enter Slave Mode. The keypad is locked from the operator. The purpose of this mode is that if communications is lost and the shed timer times out then the controller will enter a known state of operation. The configuration of the “Shed Mode and Output” and Shed Setpoint Recall are used to configure the controller’s shed state. While in Slave Mode pushing the MAN/AUTO key enters Emergency Manual mode. The local operator then has control of the output. The controller is in Monitor Mode if the Shed timer is disabled.

10.2 Reading Control Data

Overview

The following control data can be read from this instrument:

- Input 1

Register Addresses

Use the identifying codes listed in Table 10-1 to read the specific items.

A Write request for these codes will result in an Error message.

Table 10-1 Control Data Parameters

Parameter Description	Register Address		Data Type	Access	Data Range or Enumerated Selection
	Hex	Decimal			
Input #1	7B	123	FP	RD	In Engineering Units or Percentage
LSP1	27	30	FP	R/W	In Engineering Units Within Set point Limits

10.3 Miscellaneous Read Onlys

10.3.1 Register Addresses for Read Onlys

The identifying register addresses listed in Table 10-2 represent some information that is Read only. No Writes allowed.

Table 10-2 Miscellaneous Read Onlys

Parameter Description	Register Address		Data Type	Access	Data Range or Enumerated Selection
	Hex	Decimal			
Software Type	008B	139	INT	RD	READ only 38 = UDC2500 Limit
Software Version	00A7	167	INT	RD	READ only Value less than 255

10.4 Configuration Parameters

Overview

Listed on the next pages are the identifying codes for the parameters in the various Set-up Groups in this instrument. Most of the parameters are configurable through the hosts. Some are Read Only and are indicated as such and cannot be changed.

Reading or Writing

Do a Read or Write, depending on your requirements, using the identifying code and format code listed in the tables. The range or selection available for each range is listed in the tables.

10.4.1 Lock

The identifying register addresses listed in Table 10-3 -lists all the register addresses and ranges or selections for the function parameters in Set-up Group Lock.

Table 10-3 Set-up Group Lock

Parameter Description	Register Address		Data Type	Access	Data Range or Enumerated Selection
	Hex	Decimal			
Security Value	00	80	FP	R/W	0 to 9999
Lockout	0084	132	INT	R/W	0 = None 1 = Calibration 2=Configuration 3= Set Point

10.4.2 Limit

The identifying register addresses listed in Table 10-4 lists all the register addresses and ranges or selections for the function parameters in Set-up Group Limit.

Table 10-4 Set-up Group Limit

Parameter Description	Register Address		Data Type	Access	Data Range or Enumerated Selection
	Hex	Decimal			
High/Low Limit	0088	136	INT	R/W	0 = Low Limit 1 = High Limit
Power Up Selections	0089	137	INT	R/W	0 = Normal 1 = Reset
Limit Relay Latched	00C4	196	INT	R	0 = Not Latched 1 = Latched if in Limit Condition
Set Point Max	0007	7	FP	R/W	0 to 100% of PV (Engineering Units)
Set Point Min	0008	8	FP	R/W	0 to 100% of PV (Engineering Units)
Display	00B1	177	INT	R/W	0 = PV 1 = Set Point

10.4.3 Input 1

Table 10-5 lists all the register addresses and ranges or selections for the function parameters in Set-up Group Input 1.

Table 10-5 Set-up Group – Input 1

Parameter Description	Register Address		Data Type	Access	Data Range or Enumerated Selection
	Hex	Decimal			
Input 1 Type	009F	159	INT	R/W	1 = B TC 2 = E TC H 3 = E TC L 4 = J TC H 5 = J TC M 6 = J TC L 7 = K TC H 8 = K TC M 9 = K TC L 10 = NNM H 11 = NNM L 12 = Nicrosil H TC 13 = Nicrosil L TC 14 = R TC 15 = S TC 16 = T TC H 17 = T TC L 18 = W TC H 19 = W TC L 20 = 100 PT RTD 21 = 100 PT LO RTD 22 = 200 PT RTD 23 = 500 PT RTD 24 = Radiamatic RH 25 = Radiamatic RI 26 = 0-20 mA 27 = 4-20 mA 28 = 0-10 mV 29 = 0-50 mV 30 = 100 mV 31 = 0-5 Vdc 32 = 1-5 Vdc 33 = 0-10 Vdc 34 = Unused 35 = Unused 36 = Thermocouple Differential 37 = PR40-PR20 Thermocouple
ATTENTION					
Changing the Input Type will result in the loss of Field Calibration values and will restore the Factory Calibration values.					

Parameter Description	Register Address		Data Type	Access	Data Range or Enumerated Selection
	Hex	Decimal			
Input 1 Transmitter Characterization	00A9	169	INT	R/W	0 = B TC 1 = E TC H 2 = E TC L 3 = J TC H 4 = J TC M 5 = J TC L 6 = K TC H 7 = K TC M 8 = K TC L 9 = NNM H 10 = NNML 11 = Nicrosil H TC 12 = Nicrosil L TC 13 = R TC 14 = S TC 15 = T TC H 16 = T TC L 17 = W TC H 18 = W TC L 19 = 100 PT RTD 20 = 100 PT LO RTD 21 = 200 PT RTD 22 = 500 PT RTD 23 = Radiamatic RH 24 = Radiamatic RI 25 = Linear 26 = Square Root
Input 1 High Range Value	001D	029	FP	R/W	-999. to 9999. Engineering Units (Linear types only)
Input 1 Low Range Value	001E	030	FP	R/W	-999 to 9999. Engineering Units (Linear types only)
Input 1 Ratio	006A	106	FP	R/W	-10.00 to 10.00
Input 1 Bias	0069	105	FP	R/W	-10 to 10
Input 1 Filter	002A	042	FP	R/W	0 to 120 seconds
Burnout (Open Circuit Detection)	0085	133	INT	R	0 = Downscale 1 = Upscale
Emissivity	0017	023	FP	R/W	0.01 to 1.00

10.4.4 Options

Table 10-7 lists all the register addresses and ranges or selections for the function parameters in Set-up Group Options.

Table 10-6 Set-up Group – Options

Parameter Description	Register Address		Data Type	Access	Data Range or Enumerated Selection
	Hex	Decimal			
Auxiliary Output	009E	158	INT	R/W	0 = None 1 = Not Used 2 = Not Used 3 = PV
Low Scaling Factor	0031	049	FP	R/W	Within the range of the selected variable in ID 134-158
High Scaling Factor	0032	050	FP	R/W	Within the range of the selected variable in ID 134-158
Auxiliary Output Range	00EC	236	INT	R/W	0 = 4-20 mA 1 = 0-20 mA
Digital Input #1 (External Reset)	00BA	186	INT	R/W	0 = None 1 = Enable 2 = External Reset Only

10.4.5 Communications

Table 10-7 lists all the register addresses and ranges or selections for the function parameters in Set-up Group Communications.

Table 10-7 Set-up Group – Communications

Parameter Description	Register Address		Data Type	Access	Data Range or Enumerated Selection
	Hex	Decimal			
Communication Address	004D	77	FP	R/W	1 - 99
Communications Type	00E7	231	INT	R/W	0 = None 1 = Disable 2 = RS-485 Modbus 3 = Ethernet
IR Port Enable	00F1	241	INT	R/W	0 = Disable 1 = Enable
Baud Rate	00E8	232	INT	R/W	0 = 4800 1 = 9600 2 = 19200 3 = 38400
Transmit Delay	004E	78	FP	R/W	Response Delay in ms (1 to 500) +6ms
Floating Point Byte Order	00E9	233	INT	R/W	0 = Big Endian 1 = Big Endian Byte Swap 2 = Little Endian 3 = Little Endian Byte Swap
Shed Enable	00EA	234	INT	R/W	0 = Enable 1 = Disable
Shed Time	004F	79	INT	R/W	0 = No Shed 1 = 255 sample periods
Comm Data Units	00A1	161	INT	R/W	0 = Percent 1 = Engineering Units

10.4.6 Alarms

Table 10-8 lists all the register addresses and ranges or selections for the function parameters in Set-up Group Alarms.

Table 10-8 Set-up Group – Alarms

Parameter Description	Register Address		Data Type	Access	Data Range or Enumerated Selection
	Hex	Decimal			
Alarm 1 Setpoint 1 Type	008C	140	INT	R/W	0 = None 1 = Not Used 2 = Not Used 3 = PV 4 = Deviation 5 = Not Used 6 = Alarm on Shed 7 = Not Used 8 = Not Used 9 = Not Used 10 = T/C Warning 11 = Failsafe or T/C Fail 12 = PV Rate of Change 13 = Alarm on Digital Input
Alarm 1 Setpoint 1 Value	0009	009	FP	R/W	Within the range of selected parameter or PV span for deviation alarm
Alarm 1 Setpoint 2 Type	008E	142	INT	R/W	Same as 140
Alarm 1 Setpoint 2 Value	000A	010	FP	R/W	Within the range of selected parameter or PV span for deviation alarm
Alarm 2 Setpoint 1 Type	0090	144	INT	R/W	Same as 140
Alarm 2 Setpoint 1 Value	000B	011	FP	R/W	Within the range of selected parameter or PV span for deviation alarm
Alarm 2 Setpoint 2 Type	0092	146	INT	R/W	Same as 140
Alarm 2 Setpoint 2 Value	000C	012	FP	R/W	Within the range of selected parameter or PV span for deviation alarm

Parameter Description	Register Address		Data Type	Access	Data Range or Enumerated Selection
	Hex	Decimal			
Alarm 1 Setpoint 1 Event	008D	141	INT	R/W	0 = Low Alarm 1 = High Alarm
Alarm 1 Setpoint 2 Event	008F	143	INT	R/W	0 = Low Alarm 1 = High Alarm
Alarm 2 Setpoint 1 Event	0091	145	INT	R/W	0 = Low Alarm 1 = High Alarm
Alarm 2 Setpoint 2 Event	0093	147	INT	R/W	0 = Low Alarm 1 = High Alarm
Alarm Hysteresis	0029	041	FP	R/W	0.0 to 100% of output or span
Alarm Latching for Output 1	00C8	200	INT	R/W	0 = Non Latching 1 = Latching
Alarm States	00C9	201	INT	R/W	State = 0 = Not in Alarm State = 1 = In Alarm Bit 0 = Alarm 11 State Bit 1 = Alarm 12 State Bit 2 = Alarm 21 State Bit 3 = Alarm 22 State
Alarm 1 Blocking	00CA	202	INT	R/W	0 = Disable 1 = AL1 2 = AL 2 3 = AL 1 2
Diagnostic Alarm	009A	154	INT	R/W	0 = Disable 1 = Alarm 1 2 = Alarm 2

10.4.7 Display

Table 10-9 lists all the register addresses and ranges or selections for the function parameters in Set-up Group Display.

Table 10-9 Set-up Group – Display

Parameter Description	Register Address		Data Type	Access	Data Range or Enumerated Selection
	Hex	Decimal			
Decimal Point Location	009B	155	INT	R/W	0 = XXXX – Fixed 1 = XXX.X – Floating decimal point to one 2 = XX.XX – Floating decimal point to two
Temperature Units	0081	129	INT	R/W	0 = °F 1 = °C 2 = None
Power Frequency	00A6	166	INT	R/W	0 = 60 Hertz 1 = 50 Hertz
Lower Display	00AE	174	INT	R/W	0 = Enable 1 = Disable
TC Diagnostics	009F	159	INT	R/W	0 = Enable 1 = Disable

10.5 Modbus RTU Exception Codes

Introduction

When a master device sends a query to a slave device it expects a normal response. One of four possible events can occur from the master's query:

- *Slave device receives the query without a communication error and can handle the query normally.*
It returns a normal response.
- *Slave does not receive the query due to a communication error.*
No response is returned. The master program will eventually process a time-out condition for the query.
- *Slave receives the query but detects a communication error (parity, LRC or CRC).*
No response is returned. The master program will eventually process a time-out condition for the query.
- *Slave receives the query without a communication error but cannot handle it (i.e., request is to a non-existent coil or register).*
The slave will return with an exception response informing the master of the nature of the error (Illegal Data Address.)

The exception response message has two fields that differentiate it from a normal response:

Function Code Field:

In a normal response, the slave echoes the function code of the original query in the function code field of the response. All function codes have a most-significant bit (MSB) of 0 (their values are below 80 hex). In an exception response, the slave sets the MSB of the function code to 1. This makes the function code value in an exception response exactly 80 hex higher than the value would be for a normal response.

With the function code's MSB set, the master's application program can recognize the exception response and can examine the data field for the exception code.

Data Field:

In a normal response, the slave may return data or statistics in the data field. In an exception response, the slave returns an exception code in the data field. This defines the slave condition that caused the exception.

Query

Example: Internal slave error reading 2 registers starting at address 1820h from slave at slave address 02.
02 03 18 20 00 02 CRC CRC

Response

Example: Return MSB in Function Code byte set with Slave Device Failure (04) in the data field.
02 83 04 CRC CRC

Table 10-10 Modbus RTU Data Layer Status Exception Codes

Exception Code	Definition	Description
01	Illegal Function	The message received is not an allowable action for the addressed device.
02	Illegal Data Address	The address referenced in the function-dependent data section of the message is not valid in the addressed device.
03	Illegal Data Value	The value referenced at the addressed device location is no within range.
04	Slave Device Failure	The addressed device has not been able to process a valid message due to a bad device state.
05, 06	Slave Device Busy	The addressed device has ejected a message due to a busy state. Retry later.
07	NAK, Negative Acknowledge	The addressed device cannot process the current message. Issue a PROGRAM POLL to obtain device-dependent error data.
09	Buffer Overflow	The data to be returned for the requested number of registers is greater than the available buffer space. <i>Function Code 20 only.</i>

11 Ethernet TCP/IP

11.1 Overview

Ethernet parameters can only be configured via the Process Instrument Explorer software.

Ethernet IP Address is 10.0.0.2 as shipped from the Factory.

The MAC address is printed on the case label of each instrument.

When constructing a network, it is recommended that a Switch be used to connect UDCs to a LAN rather than using a Hub. This is because a Switch passes only those messages for IP addresses that are connected to the Switch while a Hub passes all message traffic. Using a Switch thus improves the overall throughput of the traffic to and from the UDCs.

12 Further information

12.1 Modbus RTU Serial Communications

Refer to document 51-52-25-66 Modbus RTU Serial Communications User Manual.

12.2 Modbus Messaging on TCP/IP

Refer to document 51-52-25-121 MODBUS Messaging on TCP/IP Implementation Guide.

12.3 How to Apply Digital Instrumentation in Severe Electrical Noise Environments

Refer to document 51-52-05-01 How to Apply Digital Instrumentation in Severe Electrical Noise Environments.

13 Index

A

Alarm Blocking, 42
Alarm Hysteresis, 123
Alarm Outputs, 9
Alarm Relay Output Failure, 96
Alarm Relays, 13
Alarm Setpoints, 57
Alarms Set Up Group, 39
Ambient Temperature, 10
Analog Input Signal Failure Operation, 8
Analog Inputs, 8
Analog Parameters, 114
Annunciators, 52
Application Related Problems, 88
Auxiliary Output, 35
Auxiliary Output Calibration, 83
Auxiliary Output Calibration Procedure, 85
Auxiliary Output Failure, 99

B

Background Tests, 91
Baud Rate, 121
Baud Rate, 37
Bias, 33
Blocking, 123
Burnout Protection, 33
Byte Count, 106

C

Calibration Mode, 80, 86
Calibration Steps, 70
CE Conformity (Europe), 6
Communicationaddress, 121
Communications Failure, 98
Communications Modes Of Operation, 114
Communications Set Up Group, 37
Communications Station Address, 37
Communications Transfer Rates, 114
Communications Type, 121
Composite Wiring Diagram, 18
Configuration, 26
Configuration Parameters, 116
Configuration Procedure, 28
Configuration Prompt Hierarchy, 27
Configuration Record Sheet, 48
Contact Input, 56
Control Relays, 13
Control/Alarm Circuit Wiring, 16
Controller Failure Symptoms, 93
Controller Grounding, 16
Controller Output Types, 9

D

Decimal Point, 43
Deviation, 35
Diagnostic Alarm, 123
Digital Input Option, 56
Digital Inputs, 8, 35
Digital Parameters, 114
Dimensions, 14
Display, 30
Display Mode, 52
Display Set Up Group, 43

E

Electrical Considerations, 16
Electrical Noise Precautions, 17
Electromechanical Relay Output, 21
Email Configuration Screen, 46
Emissivity, 34
Environmental And Operating Conditions, 10
Equipment You Will Need To Calibrate, 72
Error Messages, 53
Ethernet Communications Address, 66, 67
Ethernet Communications Option Connections, 23
Ethernet Configuration Screen, 45
Ethernet Connection, 64
Ethernet IP Address, 127
Ethernet Status, 63
Ethernet TCP/IP, 37, 127
Ethernet TCP/IP Communications Interface, 9
External Interface Option Connections, 22, 24
External Reset, 56
External Wiring, 17

F,G

Factory Calibration, 79, 85
Factory Configuration, 100
Failsafe Manual Mode, 90
Features, 1
Field Calibration, 69
Field Wiring, 72
File Number, 107, 111
Filter, 33
Floating Point Byte Order, 121
Floating Point Parameter Type, 105
Frequency, 10
Function Code 20, 106
Function Code 21, 110
Function Codes 20 And 21, 104
Function Prompts, 27

H

High And Low Limit Indication, 53
High Limit Controller, 1
High Setpoint Limit, 30

I, J

Ice Bath, 72
Infrared Communications, 5
Infrared Communications, 9
Infrared Communications, 37
Input 1 Actuation Type, 31
Input 1 And Input 2 Wiring Terminals, 72
Input 1 Calibration Procedure, 78
Input 1 Connections, 20
Input 1 High Range Value, 32
Input 1 Low Range Value, 33
Input 1 Set Up Group, 31
Input 1 Set Up Wiring, 73
Input Calibration, 69
Installation, 7
Installation Related Problems, 87
Integer Parameter Type, 105
IR Port Enable, 121
Isolation, 9

K

Key Error, 51
Key Functions, 3
Keyboard Failure, 97

L

Latching Output Relay Failure, 96
Limit, 117
Limit And Alarm Relay Contact Information, 13
Limit Control Application Diagram, 25
Limit Controller Wiring, 25
Limit Set Up Group, 30
Limit Setpoint, Setting, 55
Line Voltage, 10
Line Voltage Wiring, 16
Link Length, 37
Local Area Network (Lan) Settings, 66
Lock Set Up Group, 29
Lockout Feature, 51
Lockout Levels, 51
Loop Data – Alarm Details, 60
Loop Data – Digital Input Details, 61
Loop Data Screen, 58
Loopback, 38
Low Limit Controller, 1
Low Setpoint Limit, 30

M

Mains Power Supply, 16, 19
Mechanical Shock, 10
Minimum And Maximum Range Values, 70
Modbus, 37
Modbus Read, Write And Override Parameters, 113
Modbus Rtu Function Codes, 104
Model Number Interpretation, 11
Monitoring Your Limit Controller, 52
Mounting, 14
Mounting Method, 15
Mounting Procedure, 15

N

Non-Volatile Memory Retention, 113

O

Open Collector Relay Output, 22
Operating Principles, 54
Operating The Limit Controller, 49
Operating Your Limit Controller, 54
Operator Interface, 2, 50
Options Set Up Group, 35
Output Calibration, 83
Override Parameters, 114

P,Q

P.I.E. Tool, 64
P.I.E. Tool Ethernet And Email Configuration Screens, 45
P.I.E. Tool Maintenance Screens, 58
Parts Identification, 102
Parts List, 101
Permissible Wiring Bundling, 17
Physical Considerations, 14
Power Consumption, 9
Power Failure Symptoms, 95
Power Inrush Current, 9
Power Line Frequency, 43
Power Up, 30
Power Up Logic, 54
Power-Up Tests, 90
Pre-Installation Information, 8
Process Instrument Explorer, 4

R

Read Onlys, 115
Reading Control Data, 115
Register Address, 107, 111
Register Address Structure, 105
Register Addresses, 116
Register Count, 105
Relative Humidity, 10
Relay Contacts, 57
Removing The Chassis, 103
Reset The Latching Relay, 56

Resistance Thermometer Device, 72
Restore Input Factory Calibration, 79
Restore Output Factory Calibration, 85
RS422/485 Modbus RTU Comm Interface, 9
RTD Inputs, 74

S

Security Code, 50
Security Code Entry, 51
Set Up Group, 27
Set Up Wiring Procedure For Auxiliary Output, 84
Shed Enable, 121
Shed Enable, 38
Shed Time, 37
Shed Time, 121
Shed Time, 38
Software Type, 115, 116, 117
Software Version, 115, 117
Software Version Number, 89
Solid State Relay Output, 21
Specifications, 8
Status Data, 62
Status Tests, 90
Stray Rejection, 8
Suppression Devices, 17

T

T/C Source, 72
Temperature Units, 43
Test Failures, 90
Thermocouple Failing, 39

Thermocouple Inputs Using A Thermocouple Source, 74

Thermocouple Inputs Using An Ice Bath, 73

Thermocouple Warning, 39

Timing Out From Lower Display, 52

Transmit Delay, 121

Transmitter Characterization, 32

Troubleshooting Aids, 88

Troubleshooting Procedures, 94

Troubleshooting/Service, 87

TX Delay, 38

U

UDC2500 Limit Controllers, 1

V

Vibration, 10

Viewing The Operating Parameters, 52

Voltage And Resistance Equivalents For 0% And 100% Range Values, 70

W, X, Y, Z

Weight, 10

Wiring, 16

Wiring Bundling, 17

Wiring Connections For Calibrating Auxiliary Output, 84

Wiring Connections For Radiomatic, Milliampere, Millivolts, Or Volts (Except 0 To 10 Volts), 75, 77

Wiring Connections For Rtd (Resistance Thermometer Device), 74

Wiring Diagrams, 18

Wiring The Controller, 18

